

V.M.V.V Sangha's

V.M. K. S. R. Vastrad Arts Science And V.S
Bellihal Commerce college, Hungund

Department of Botany Year 2022-2023

Project reports by B.sc I semester students



Principal

Vijaya Mahantesh Krupaposhit
S R.Vastrad Arts, Science & V S.Bellihal
Commerce College, Hungund-587115

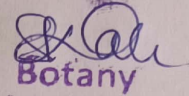

Sl.no	Reg. No.	Student Name	Project topic
1	U15IY22S0004	Shivashankarappa	Microbiology equipments
2	U15IY22S0005	Adil	Microbiology equipments
3	U15IY22S0016	Harish	Microbiology equipments
4	U15IY22S0025	Aishwarya	Microbiology equipments
5	U15IY22S0032	Jhanavi	Microbiology equipments

Botany

Head of the Department
V.M.K.S.R Vastrad Arts, Commerce And
Science College, Hungund Dist: Bagalkot

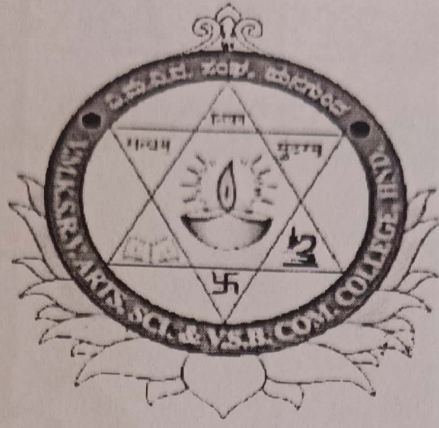

V.M.K.S.R.VASTRADARTS, SCIENCE,&
V.S.BELLIHAL COMMERCE COLLEGE HUNGUND.

PROJECTREPORT

College Roll No: 05 Examination seat No: UJSTY22S0005

CERTIFICATE

This is to certify that Mr./Miss: Adil J. Mudakavi of
B.Sc 1stsemester has satisfactorily completed the visit on
Microbiology equipments of Botany subject as prescribed by the Rani
Chennammna University Belagavi.

During year 2022-2023

Examiner: HOD

1). Pd/pof
..... 23/2/23

2). theleey
..... 23/2/23

SKa
Botany
Head of the Department
V.M.K.S.R Vastrad Arts, Commerce and
Hungund College

V.M.S.R VASTRAD ARTS, SCIENCE &
V.S BELLIHAL COMMERCE COLLEGE,
HUNGUND.

MICROBIOLOGY EQUIPMENTS

Project done by

ADIL.I.MUDAKAVI

Reg No : U15IY22S0005

BSc 1st Sem

BOTANY

RANI CHENNAMMA UNIVERSITY BELAGAVI

2022-23



List of equipment / apparatus used in microbiology laboratory

1. Autoclave
2. Incubator
3. Hot air oven
4. Inoculating loop
5. Vortex mixer / shaker
6. Water bath
7. Heating mantle
8. Hot plate with magnetic stirrer
9. UV chamber
10. Inoculation chamber
11. pH meter
12. Colony counter
13. Microscope
14. Refrigerator
15. Bunsen burner
16. Spirit lamp
17. Micrometer (stage and ocular)
18. Balance (Digital and 4-beam)
19. Thermometer
20. Membrane filter set

DESCRIPTION

1. Autoclave

It is a robust, electrically heated steam vessel meant for sterilizing 'thermostable' culture media, glassware, and other materials that are not spoiled by moist heat. Autoclave runs on the principle of pressure cooker. The moist heat (steam) has a very good penetrating power. Microorganisms / cells are killed as a result of denaturation of cellular constituents (protein and nucleic acids). In routine process, sterilization can be achieved by operating the autoclave at 121°C (15 psig) for 15 min.

In its simplest form, the equipment has a removable lid for the delivery of materials to be sterilized. It is necessarily equipped with a gasket, pressure-cum-temperature gauge, a vent for letting out air or excess pressure, a safety valve, and a drain. The figure of a portable autoclave is given in Fig. 1.

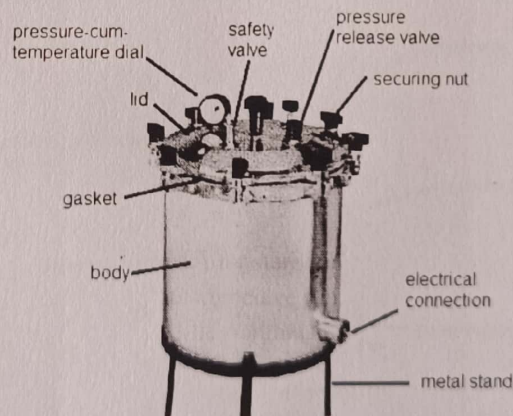

Fig. 1 Portable autoclave

2. Incubator

This is an insulated, electrically heated cabinet meant for providing microorganisms with optimum temperature for growth. The cabinet is insulated and thermostatically controlled. For routine purposes, the temperature is maintained at 28-30°C for bacteria, about 25°C for molds, and 35-37°C for mesophilic bacteria. A temperature as

high as 100°C can also be maintained for extremely thermophilic organisms (stereothermophiles). A very common laboratory incubator is shown in Fig. 2.

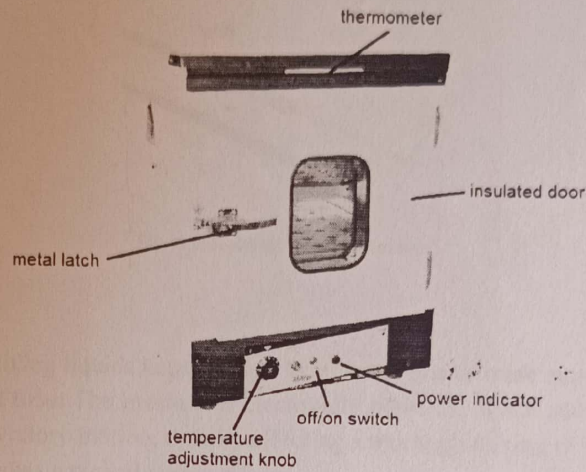

Fig. 2 Incubator

3. Hot air oven

This is similar to incubator in make except that it can operate at temperatures up to 300°C and has a fan for circulating hot air. Hot air oven is used for sterilization of glassware and materials that are spoiled by moist heat. The death of cells occurs due to the oxidation of cellular constituents by the dry heat.

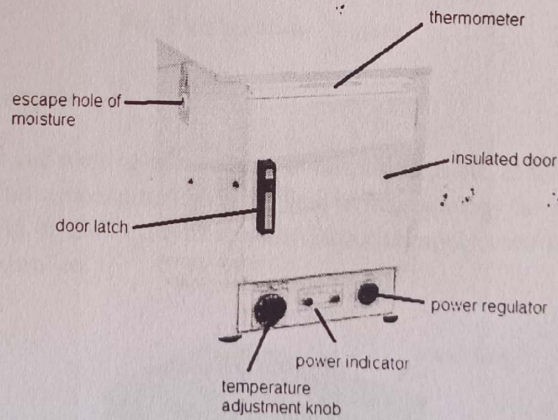

Fig. 3 Hot air oven

For routine purpose, sterilization can be achieved by running the equipment at 180°C for 1.5 hours. Hot air oven is less effective than autoclave. Fig. 3 shows a typical hot air oven popular in microbiology laboratories.

4. Inoculating loop

This is a tool for transferring and streaking cultures. It consists of a thin nichrome wire whose one end is twisted into a small loop while the other end is fixed to a thermoset plastic handle. Sometimes, the looped end is

straightened out to form what is called inoculating needle. Inoculating needles are used for preparing 'stab' cultures. Fig. 4 shows inoculating loops and needles.

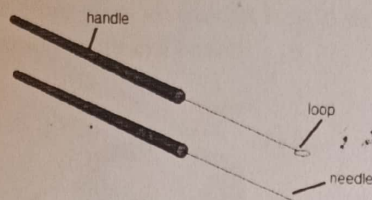

Fig. 4 Inoculating loop and needle

5. Vortex mixer

This equipment is used for mixing liquids kept in a test tube. It has one or more cup-like depressions at the top to receive the bottom of the test tube. The machine is electrically powered. When actuated, the machine moves the bottom of the test tube in a gyratory motion, thereby affecting a thorough mixing of the solution. The speed of the mixer can be varied. Fig. 5 shows a typical vortex mixer.

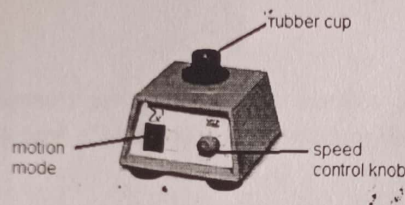

Fig. 5 Vortex mixer / shaker

6. Water bath / Boiling water bath

Water bath is used for heating and melting of media, solutions, samples etc. at temperatures below 100°C. It can also be used to maintain constant temperature that is required in microbiology lab work. Several models and types of water bath are available. Fig. 6 shows a typical water bath commonly used in laboratories. It is electrically heated and thermostatically controlled.

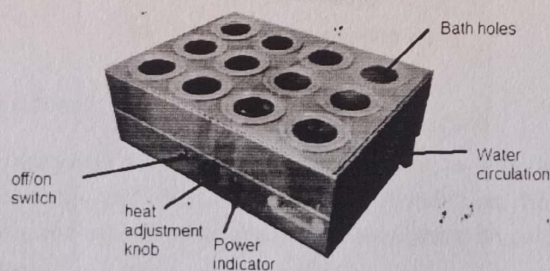

Fig. 6 Boiling water bath

7. Heating mantle

It is an electrically heated and thermostatically controlled unit used to heat or melt samples and reagents. The inner lining is made of asbestos and therefore gives an indirect heat to the materials to be heated. Fig. 7 shows a typical heating mantle being used for heating water in a beaker.

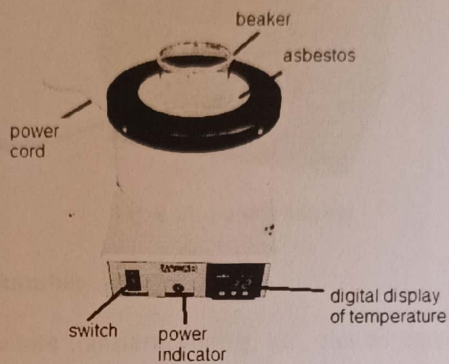

Fig. 7 Heating mantle

8. Hot plate with magnetic stirrer

This is an electrically powered equipment performs the dual function of heating and agitation. The agitation occurs by magnetic arrangement. Any type of glassware can be used for the heating and agitation. Magnetic beads are used for the agitation.

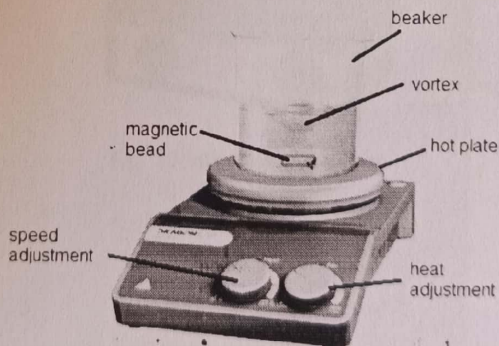

Fig. 8 Hot plate with magnetic stirrer

9. UV chamber / UV viewing cabinet

This equipment is used for analyzing fluorescent materials, spots in thin layer chromatography, etc. The equipment has two lamps for long- and short wavelength UV radiation. Since UV radiation is genotoxic (mutagenic) its exposure to skins and eyes must be avoided. A viewport with colored glass is provided for safety. Fig. 9 shows a typical UV cabinet.

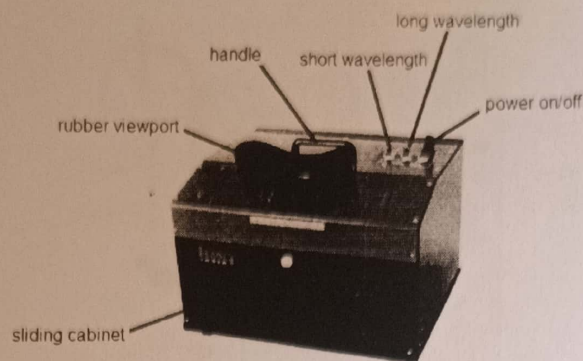

Fig. 9 UV viewing cabinet

11. Inoculation chamber / Sterile chamber

This is an enclosed box in which culture transfers, plating, etc. can be carried out aseptically. The chamber is equipped with UV lamp for periodic disinfection of the chamber. While working, the UV light must be turned off and day-light bulb is turned on. Fig. 10 shows a locally fabricated inoculation chamber.

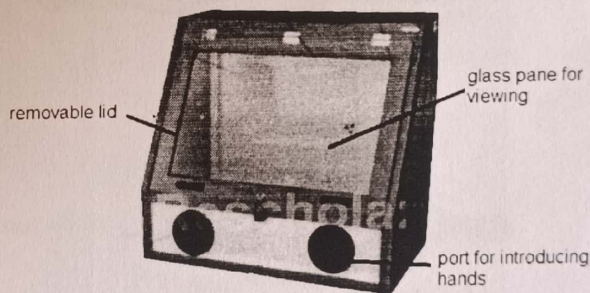

Fig. 10 Inoculation chamber

11 pH meter

pH meter is an electrical instrument used for measuring hydrogen ion concentration of solutions and mixtures (Fig. 11). In microbiology lab, it is used for maintaining pH of the medium and diluents. The pH meter must be standardized with buffer solutions before operation. Since the instrument is very sensitive, it must not be used for stirring and it must not be dipped in hot or very cold solutions. The electrodes must always be kept immersed in suitable solutions. Read the manual carefully before using the instrument.

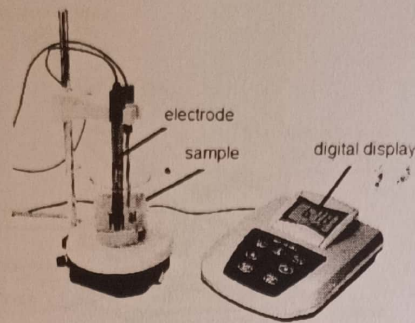

Fig. 11 pH meter

12. Colony counter

It is used for counting microbial colony (bacterial and yeast). The instrument is equipped with a backlight source, gridlines and a magnifying lens. It also has a sensor for digitally registering the number of colonies counted (Fig. 12).

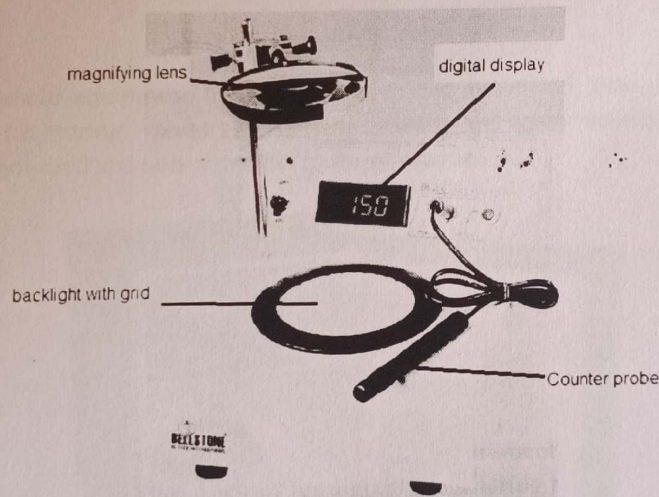

Fig. 12 Colony counter

13. Microscope

It is an instrument for observing microscopic items such as cells, crystals and cell organelles. It has the dual function of magnification and resolution. For routine microbiological works, bright field compound microscope with oil immersion objective is adequate. A compound microscope is shown in Fig. 13.

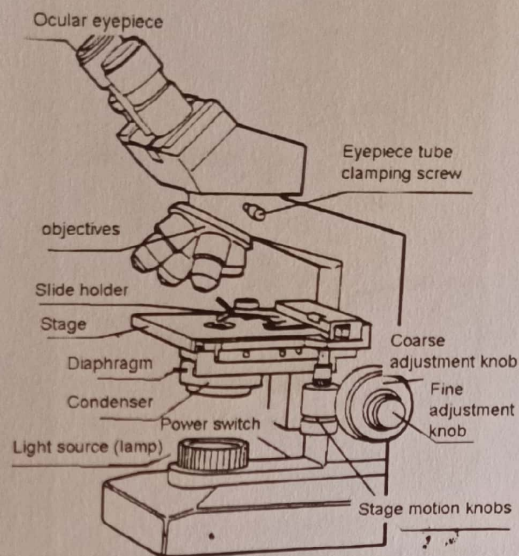

Fig. 13 Compound microscope

14. Refrigerator

This is a common household equipment for keeping foods and beverages cool. This equipment is used in microbiology laboratory for storing / preserving cultures, media, and many sensitive materials (Fig. 14). The equipment is electrically powered and uses ammonia as the refrigerant.



Fig. 14 Refrigerator

15. Bunsen burner

Bunsen burner is a common tool used in science lab (Fig. 15). In microbiology lab, it is used for sterilizing inoculating loop, plating out cultures, transferring cultures, heat-fixing of smears and creating a sterile zone for aseptic operation.

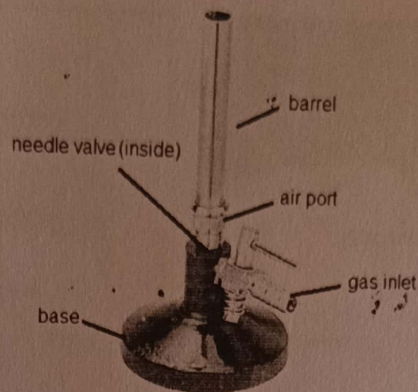

Fig 15 Bunsen burner

16. Spirit lamp

The function of spirit lamp is the same as the Bunsen burner but is portable. It uses rectified spirit as the fuel (produces smoke-free flame). The lamp must be covered with a lid when not in use to prevent loss of spirit (Fig. 16).

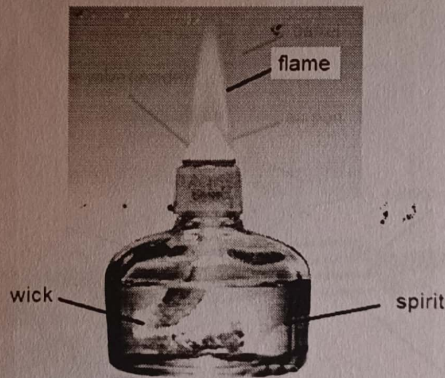

Fig. 16 Spirit lamp

17. Micrometers (stage and ocular)

These are graduated glass pieces (Fig. 17) used for the measurement of size of the cells. Stage micrometer is a slide on which etching is done with 0.001 mm spacing. The ocular micrometer, which is placed on the eyepiece, has an arbitrary scale and must be calibrated against the stage micrometer. During measurements, the ocular micrometer is retained while the stage micrometer is replaced with the specimen slide.

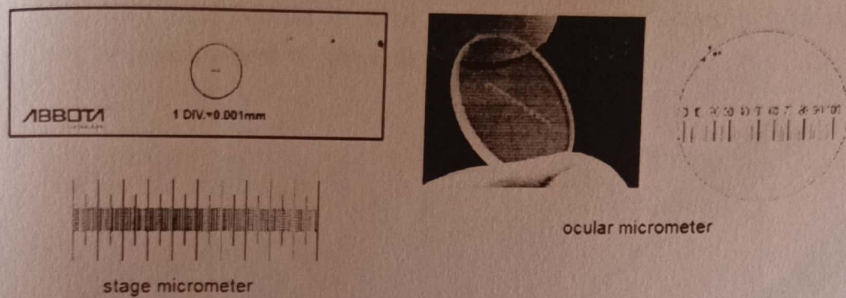

Fig. 17 Stage and ocular micrometer

18. Balance

Balance is needed in microbiology lab for weighing chemicals, samples, media, etc. Digital balances are fast to work with but needs frequent calibration (Fig. 18).

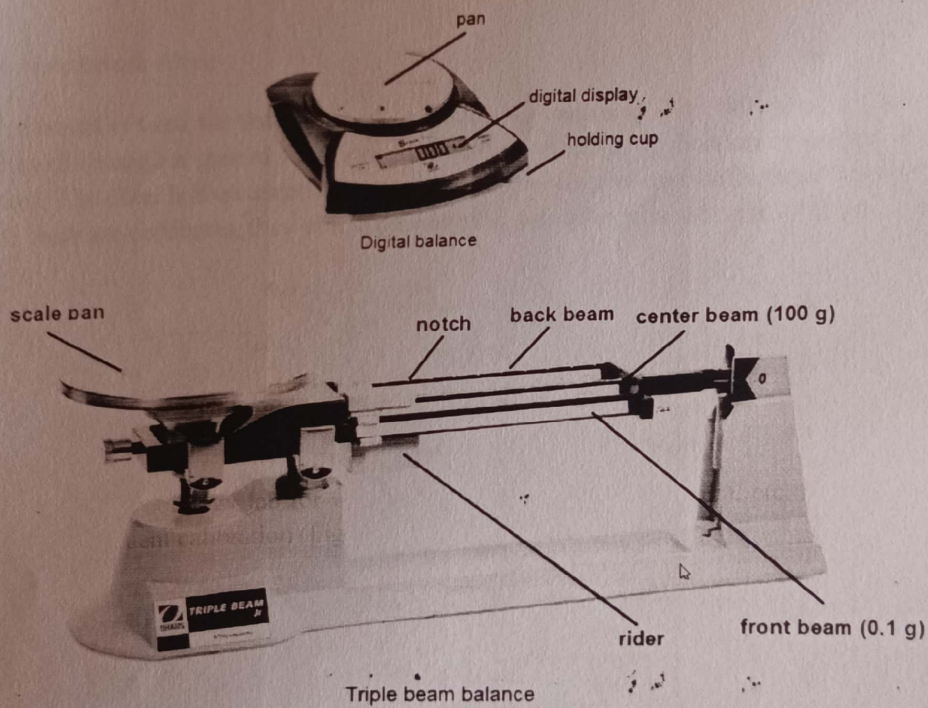

Fig. 18 Different types of balances

The triple-beam and 4-beam balances are robust equipment that need little care and maintenance. Beam balances run on mechanical principles while the principles on which electronic balances run is quite complicated (Fig. 19).

19. Thermometer

Thermometers are required to ensure the heating equipment is running at the correct temperature. The temperature of the medium, incubator, etc., need to be frequently checked. Mercury in glass thermometers are standard

thermometers, the temperature measurement is based on the expansion of mercury present in the bulb. Digital thermometers use probes for measurement of temperatures.

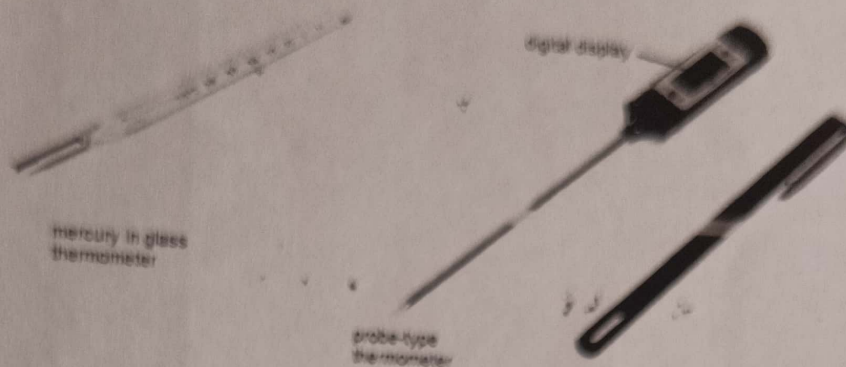

Fig. 19 Different types of thermometers

20. Coliform membrane filter

This glass equipment is used for the testing of coliforms in water (Fig. 20). 100 ml of test water is poured in the funnel and filtered through a special Millipore filter through external application of suction. The filter retains the microorganisms. The filter is then aseptically transferred to a selective-cum-differential semisolid medium kept in a petri dish. If there are coliforms, they will appear as pink dots after incubation at 35°C for 22 hrs.

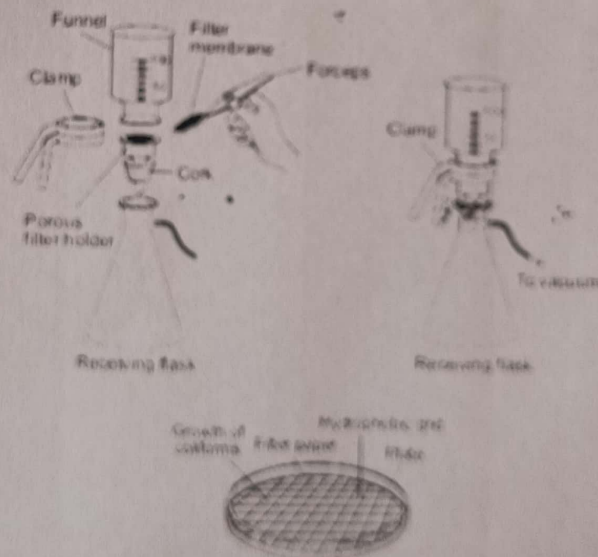
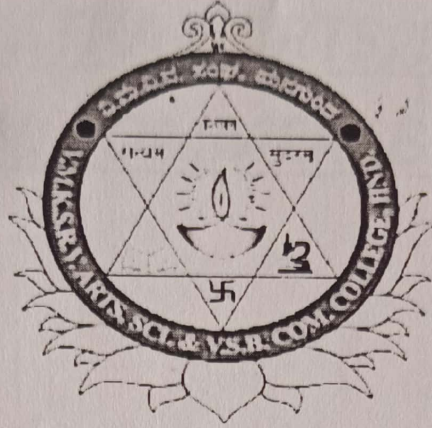

Fig. 20 Coliform membrane filter



V.M.K.S.R.VASTRADARTS, SCIENCE,&
V.S.BELLIHAL COMMERCE COLLEGE HUNGUND.

PROJECTREPORT

College Roll No: 16 Examination seat No: U15I422S0016

CERTIFICATE

This is to certify that Mr./Miss: Harish. H. Hoonoor of
B.Sc 1stsemester has satisfactorily completed the visit on
Microbiology equipments of Botany subject as prescribed by the Rani
Chennamma University Belagavi.

During year 2022-2023

Examiner: HOD

1). Polipol
23/12/23

2). Huleeg
23/12/23

[Signature]
Botany
Head of the Department
V.M.K.S.R.Vastrad Arts, Commerce And
Science College Hungund. Dist. S

V.M.S.R VASTRAD ARTS, SCIENCE &
V.S BELLIHAL COMMERCE COLLEGE,
HUNGUND.

MICROBIOLOGY EQUIPMENTS

Project done by

HARISH.H.HOONOOR

Reg No : U15IY22S0016

BSc 1st Sem

BOTANY

RANI CHENNAMMA UNIVERSITY BELAGAVI

2022-23



List of equipment / apparatus used in microbiology laboratory

1. Autoclave
2. Incubator
3. Hot air oven
4. Inoculating loop
5. Vortex mixer / shaker
6. Water bath
7. Heating mantle
8. Hot plate with magnetic stirrer
9. UV chamber
10. Inoculation chamber
11. pH meter
12. Colony counter
13. Microscope
14. Refrigerator
15. Bunsen burner
16. Spirit lamp
17. Micrometer (stage and ocular)
18. Balance (Digital and 4-beam)
19. Thermometer
20. Membrane filter set

DESCRIPTION

1. Autoclave

It is a robust, electrically heated steam vessel meant for sterilizing 'thermostable' culture media, glassware, and other materials that are not spoiled by moist heat. Autoclave runs on the principle of pressure cooker. The moist heat (steam) has a very good penetrating power. Microorganisms / cells are killed as a result of denaturation of cellular constituents (protein and nucleic acids). In routine process, sterilization can be achieved by operating the autoclave at 121°C (15 psig) for 15 min.

In its simplest form, the equipment has a removable lid for the delivery of materials to be sterilized. It is necessarily equipped with a gasket, pressure-cum-temperature gauge, a vent for letting out air or excess pressure, a safety valve, and a drain. The figure of a portable autoclave is given in Fig. 1.

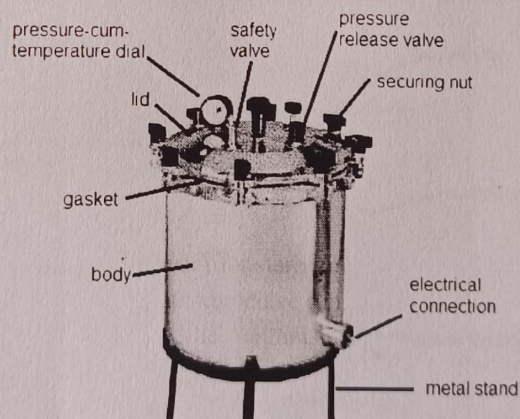

Fig 1 Portable autoclave

2. Incubator

This is an insulated, electrically heated cabinet meant for providing microorganisms with optimum temperature for growth. The cabinet is insulated and thermostatically controlled. For routine purposes, the temperature is maintained at 28-30°C for bacteria, about 25°C for molds, and 35-37°C for mesophilic bacteria. A temperature as

high as 100°C can also be maintained for extremely thermophilic organisms (stereothermophiles). A very common laboratory incubator is shown in Fig. 2.

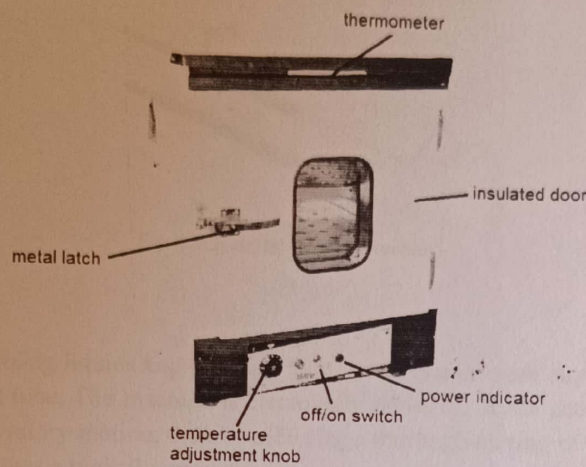

Fig. 2 Incubator

3. Hot air oven

This is similar to incubator in make except that it can operate at temperatures up to 300°C and has a fan for circulating hot air. Hot air oven is used for sterilization of glassware and materials that are spoiled by moist heat. The death of cells occurs due to the oxidation of cellular constituents by the dry heat.

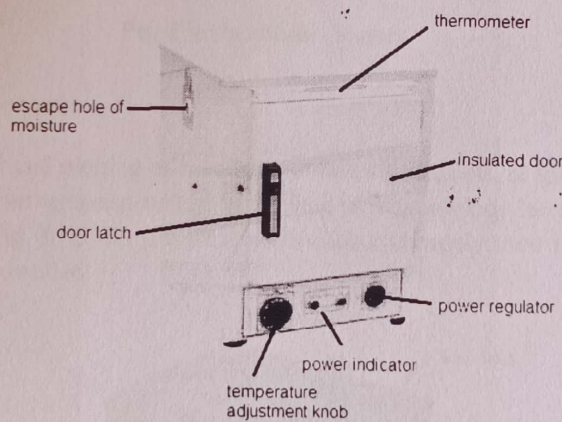

Fig. 3 Hot air oven

For routine purpose, sterilization can be achieved by running the equipment at 180°C for 1.5 hours. Hot air oven is less effective than autoclave. Fig. 3 shows a typical hot air oven popular in microbiology laboratories.

4. Inoculating loop

This is a tool for transferring and streaking cultures. It consists of a thin nichrome wire whose one end is twisted into a small loop while the other end is fixed to a thermoset plastic handle. Sometimes, the looped end is

straightened out to form what is called inoculating needle. Inoculating needles are used for preparing 'stab' cultures. Fig. 4 shows inoculating loops and needles.

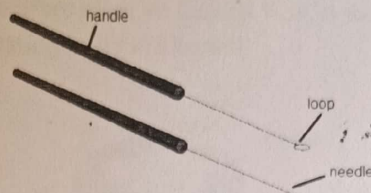

Fig. 4 Inoculating loop and needle

5. Vortex mixer

This equipment is used for mixing liquids kept in a test tube. It has one or more cup-like depressions at the top to receive the bottom of the test tube. The machine is electrically powered. When actuated, the machine moves the bottom of the test tube in a gyratory motion, thereby affecting a thorough mixing of the solution. The speed of the mixer can be varied. Fig. 5 shows a typical vortex mixer.

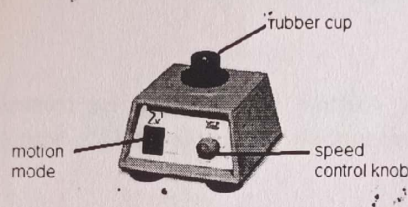

Fig. 5 Vortex mixer / shaker

6. Water bath / Boiling water bath

Water bath is used for heating and melting of media, solutions, samples etc. at temperatures below 100°C. It can also be used to maintain constant temperature that is required in microbiology lab work. Several models and types of water bath are available. Fig. 6 shows a typical water bath commonly used in laboratories. It is electrically heated and thermostatically controlled.

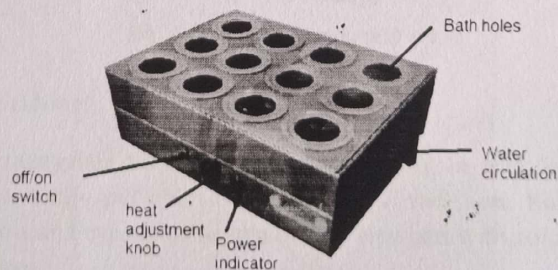

Fig. 6 Boiling water bath

7. Heating mantle

It is an electrically heated and thermostatically controlled unit used to heat or melt samples and reagents. The inner lining is made of asbestos and therefore gives an indirect heat to the materials to be heated. Fig. 7 shows a typical heating mantle being used for heating water in a beaker.

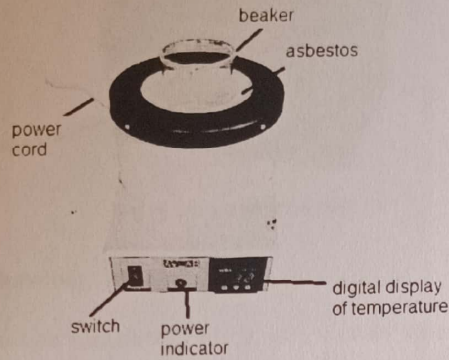

Fig. 7 Heating mantle

8. Hot plate with magnetic stirrer

This is an electrically powered equipment performs the dual function of heating and agitation. The agitation occurs by magnetic arrangement. Any type of glassware can be used for the heating and agitation. Magnetic beads are used for the agitation.

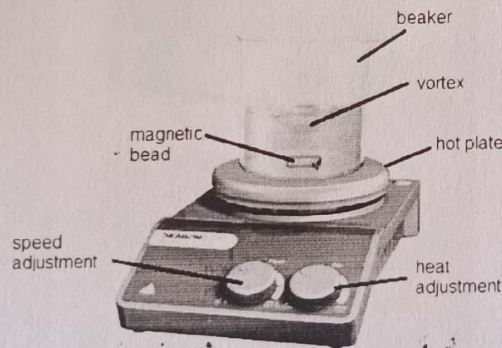

Fig. 8 Hot plate with magnetic stirrer

9. UV chamber / UV viewing cabinet

This equipment is used for analyzing fluorescent materials, spots in thin layer chromatography, etc. The equipment has two lamps for long- and short wavelength UV radiation. Since UV radiation is genotoxic (mutagenic) its exposure to skins and eyes must be avoided. A viewport with colored glass is provided for safety. Fig. 9 shows a typical UV cabinet.

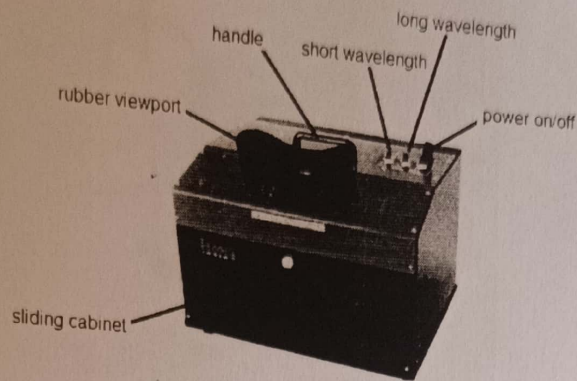

Fig. 9 UV viewing cabinet

11. Inoculation chamber / Sterile chamber

This is an enclosed box in which culture transfers, plating, etc. can be carried out aseptically. The chamber is equipped with UV lamp for periodic disinfection of the chamber. While working, the UV light must be turned off and day-light bulb is turned on. Fig. 10 shows a locally fabricated inoculation chamber.

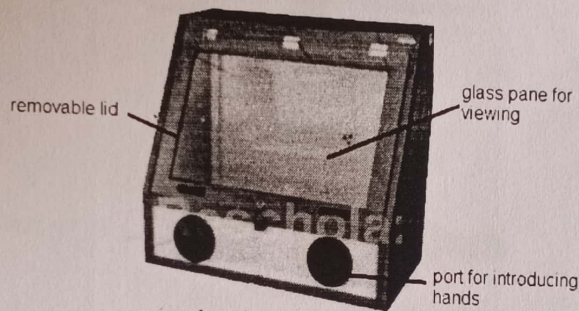

Fig. 10 Inoculation chamber

11 pH meter

pH meter is an electrical instrument used for measuring hydrogen ion concentration of solutions and mixtures (Fig. 11). In microbiology lab, it is used for maintaining pH of the medium and diluents. The pH meter must be standardized with buffer solutions before operation. Since the instrument is very sensitive, it must not be used for stirring and it must not be dipped in hot or very cold solutions. The electrodes must always be kept immersed in suitable solutions. Read the manual carefully before using the instrument.

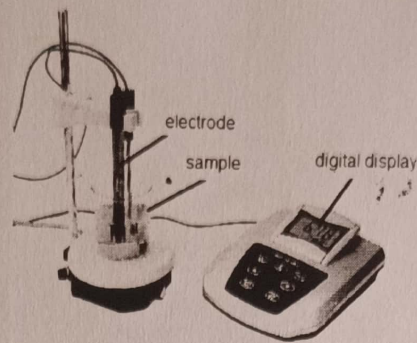

Fig. 11 pH meter

12. Colony counter

It is used for counting microbial colony (bacterial and yeast). The instrument is equipped with a backlight source, gridlines and a magnifying lens. It also has a sensor for digitally registering the number of colonies counted (Fig. 12).

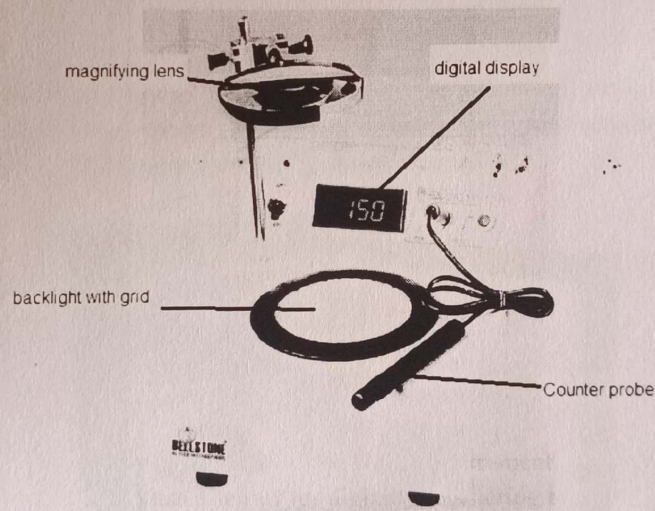

Fig. 12 Colony counter

13. Microscope

It is an instrument for observing microscopic items such as cells, crystals and cell organelles. It has the dual function of magnification and resolution. For routine microbiological works, bright field compound microscope with oil immersion objective is adequate. A compound microscope is shown in Fig. 13.

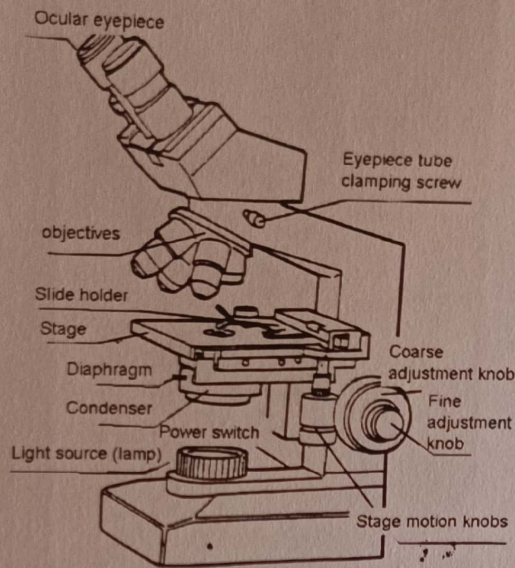

Fig. 13 Compound microscope

14. Refrigerator

This is a common household equipment for keeping foods and beverages cool. This equipment is used in microbiology laboratory for storing / preserving cultures, media, and many sensitive materials (Fig. 14). The equipment is electrically powered and uses ammonia as the refrigerant.



Fig. 14 Refrigerator

15. Bunsen burner

Bunsen burner is a common tool used in science lab (Fig. 15). In microbiology lab, it is used for sterilizing inoculating loop, plating out cultures, transferring cultures, heat-fixing of smears and creating a sterile zone for aseptic operation.

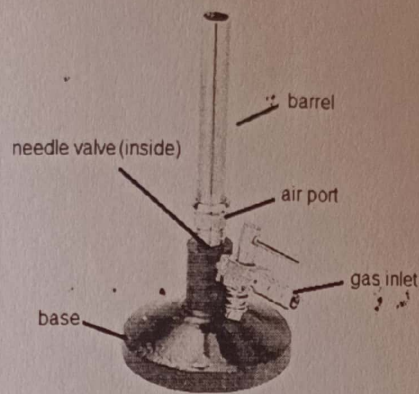

Fig 15 Bunsen burner

16. Spirit lamp

The function of spirit lamp is the same as the Bunsen burner but is portable. It uses rectified spirit as the fuel (produces smoke-free flame). The lamp must be covered with a lid when not in use to prevent loss of spirit (Fig. 16).

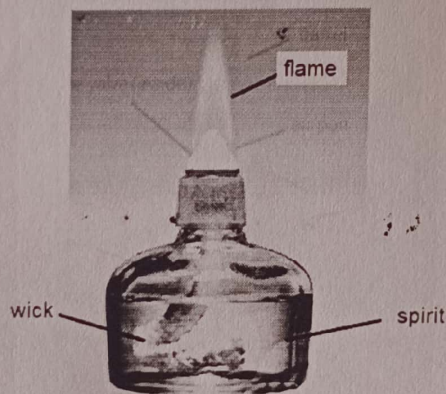

Fig. 16 Spirit lamp

17. Micrometers (stage and ocular)

These are graduated glass pieces (Fig. 17) used for the measurement of size of the cells. Stage micrometer is a slide on which etching is done with 0.001 mm spacing. The ocular micrometer, which is placed on the eyepiece, has an arbitrary scale and must be calibrated against the stage micrometer. During measurements, the ocular micrometer is retained while the stage micrometer is replaced with the specimen slide.

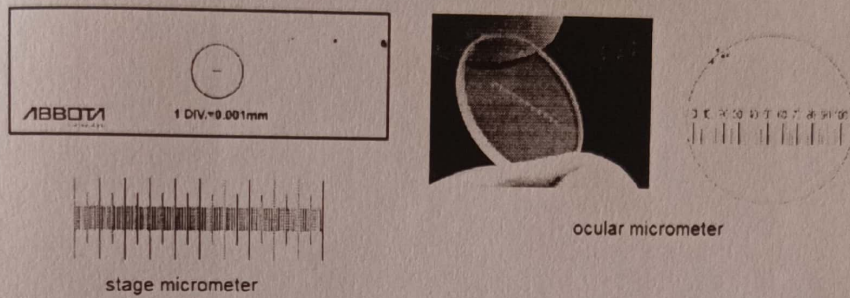

Fig. 17 Stage and ocular micrometer

18. Balance

Balance is needed in microbiology lab for weighing chemicals, samples, media, etc. Digital balances are fast to work with but needs frequent calibration (Fig. 18).

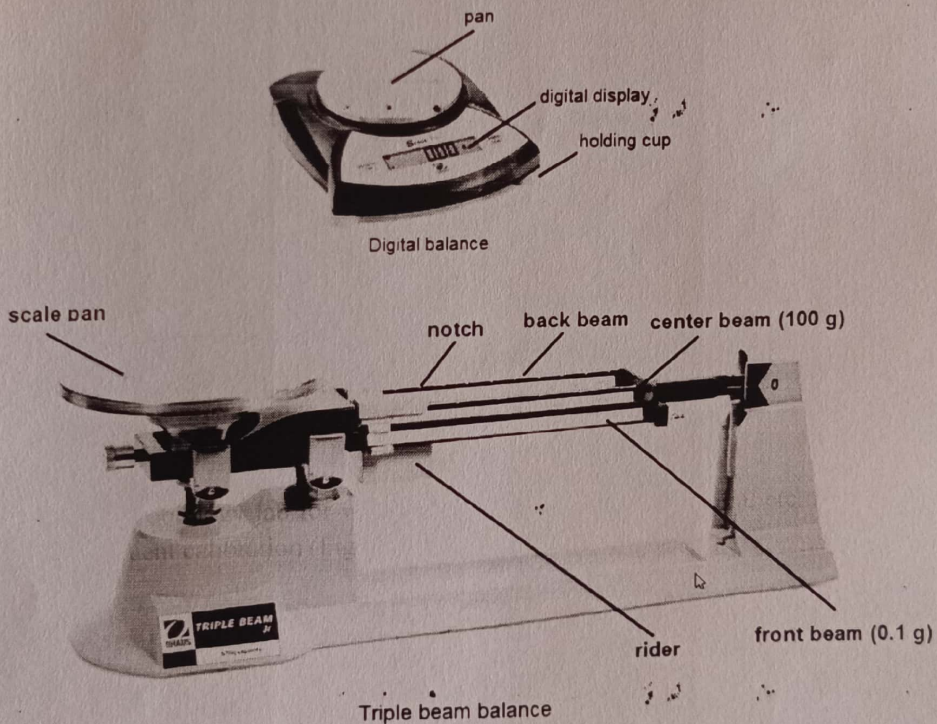

Fig. 18 Different types of balances

The triple-beam and 4-beam balances are robust equipment that need little care and maintenance. Beam balances run on mechanical principles while the principles on which electronic balances run is quite complicated (Fig. 19).

19. Thermometer

Thermometers are required to ensure the heating equipment is running at the correct temperature. The temperature of the medium, incubator, etc., need to be frequently checked. Mercury in glass thermometers are standard

thermometers, the temperature measurement is based on the expansion of mercury present in the bulb. Digital thermometers use probes for measurement of temperatures.

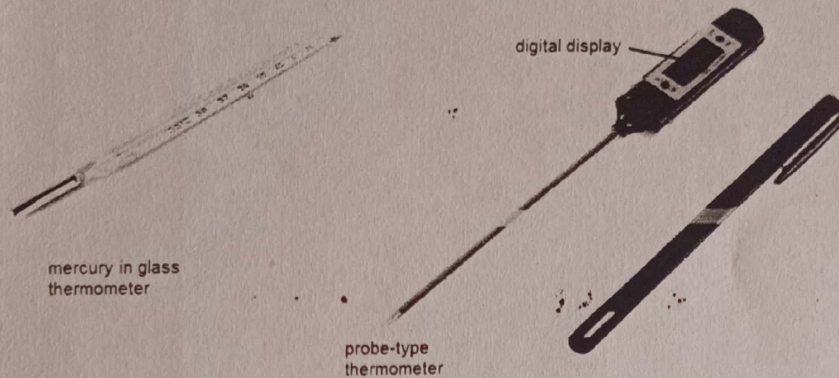

Fig. 19 Different types of thermometers

20. Coliform membrane filter

This glass equipment is used for the testing of coliforms in water (Fig. 20). 100 ml of test water is poured in the funnel and filtered through a special Millipore filter through external application of suction. The filter retains the microorganisms. The filter is then aseptically transferred to a selective-cum-differential semisolid medium kept in a petri dish. If there are coliforms, they will appear as pink dots after incubation at 35°C for 22 hrs.

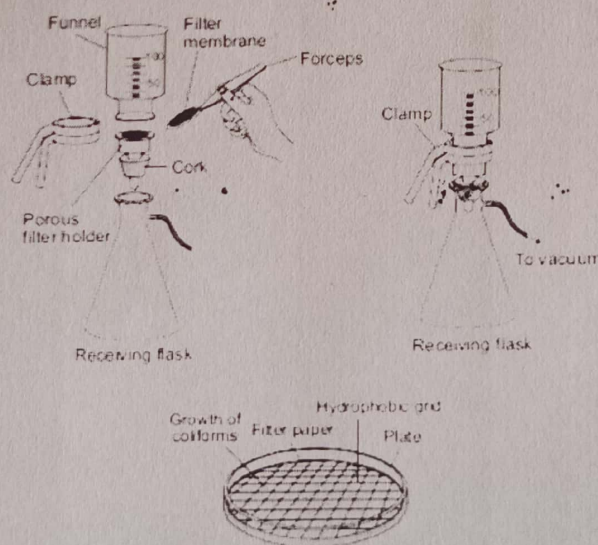
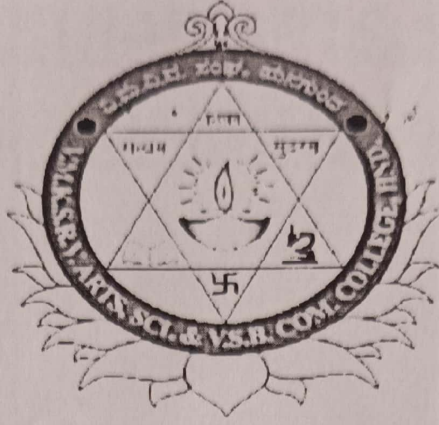

Fig. 20 Coliform membrane filter



V.M.K.S.R. VASTRAD ARTS, SCIENCE, &
V.S. BELLIHAL COMMERCE COLLEGE HUNGUND.

PROJECT REPORT

College Roll No: 32 Examination seat No: U15142250032

CERTIFICATE

This is to certify that Mr./Miss: Janavi. V. Devaraddi of
B.Sc 1st semester has satisfactorily completed the visit on
Microbiology equipments of Botany subject as prescribed by the Rani
Chennamma University Belagavi.

During year 2022-2023

Examiner: HOD

1. Polpud
23/2/23

2. Huleegys
23/2/2023

[Signature]
Botany

Head of the Department
V.M.K.S.R. Vastrad Arts, Commerce And
Science College, Hungund. Dist. Ballari.

V.M.S.R VASTRAD ARTS, SCIENCE &
V.S BELLIHAL COMMERCE COLLEGE,
HUNGUND.

MICROBIOLOGY EQUIPMENTS

Project done by

JANAVI.V.DEVARADDI

Reg No : U15IY22S0032

BSc 1st Sem

BOTANY

RANI CHENNAMMA UNIVERSITY BELAGAVI

2022-23



List of equipment / apparatus used in microbiology laboratory

1. Autoclave
2. Incubator
3. Hot air oven
4. Inoculating loop
5. Vortex mixer / shaker
6. Water bath
7. Heating mantle
8. Hot plate with magnetic stirrer
9. UV chamber
10. Inoculation chamber
11. pH meter
12. Colony counter
13. Microscope
14. Refrigerator
15. Bunsen burner
16. Spirit lamp
17. Micrometer (stage and ocular)
18. Balance (Digital and 4-beam)
19. Thermometer
20. Membrane filter set

DESCRIPTION

1. Autoclave

It is a robust, electrically heated steam vessel meant for sterilizing 'thermostable' culture media, glassware, and other materials that are not spoiled by moist heat. Autoclave runs on the principle of pressure cooker. The moist heat (steam) has a very good penetrating power. Microorganisms / cells are killed as a result of denaturation of cellular constituents (protein and nucleic acids). In routine process, sterilization can be achieved by operating the autoclave at 121°C (15 psig) for 15 min.

In its simplest form, the equipment has a removable lid for the delivery of materials to be sterilized. It is necessarily equipped with a gasket, pressure-cum-temperature gauge, a vent for letting out air or excess pressure, a safety valve, and a drain. The figure of a portable autoclave is given in Fig. 1.

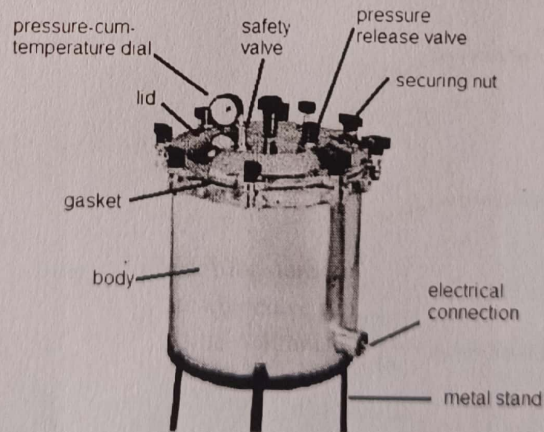

Fig 1 Portable autoclave

2. Incubator

This is an insulated, electrically heated cabinet meant for providing microorganisms with optimum temperature for growth. The cabinet is insulated and thermostatically controlled. For routine purposes, the temperature is maintained at 28-30°C for bacteria, about 25°C for molds, and 35-37°C for mesophilic bacteria. A temperature as

high as 100°C can also be maintained for extremely thermophilic organisms (stereothermophiles). A very common laboratory incubator is shown in Fig. 2.

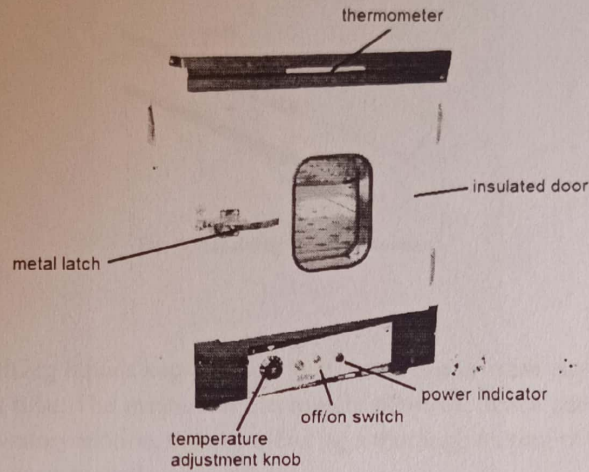

Fig. 2 Incubator

3. Hot air oven

This is similar to incubator in make except that it can operate at temperatures up to 300°C and has a fan for circulating hot air. Hot air oven is used for sterilization of glassware and materials that are spoiled by moist heat. The death of cells occurs due to the oxidation of cellular constituents by the dry heat.

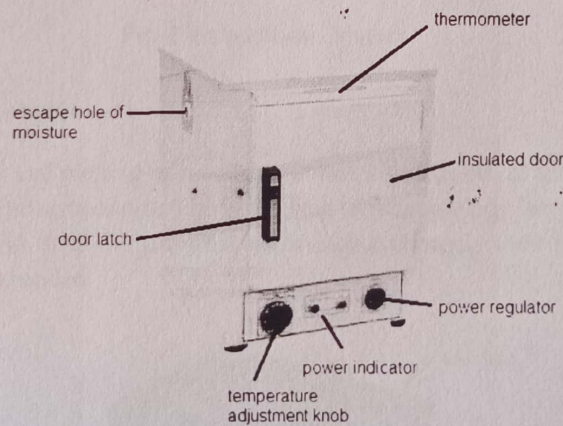

Fig. 3 Hot air oven

For routine purpose, sterilization can be achieved by running the equipment at 180°C for 1.5 hours. Hot air oven is less effective than autoclave. Fig. 3 shows a typical hot air oven popular in microbiology laboratories.

4. Inoculating loop

This is a tool for transferring and streaking cultures. It consists of a thin nichrome wire whose one end is twisted into a small loop while the other end is fixed to a thermoset plastic handle. Sometimes, the looped end is

straightened out to form what is called inoculating needle. Inoculating needles are used for preparing 'stab' cultures. Fig. 4 shows inoculating loops and needles.

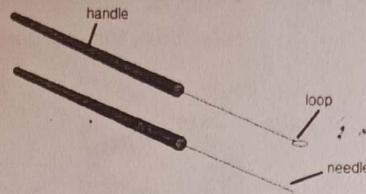

Fig. 4 Inoculating loop and needle

5. Vortex mixer

This equipment is used for mixing liquids kept in a test tube. It has one or more cup-like depressions at the top to receive the bottom of the test tube. The machine is electrically powered. When actuated, the machine moves the bottom of the test tube in a gyratory motion, thereby affecting a thorough mixing of the solution. The speed of the mixer can be varied. Fig. 5 shows a typical vortex mixer.

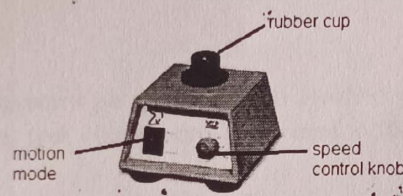

Fig. 5 Vortex mixer / shaker

6. Water bath / Boiling water bath

Water bath is used for heating and melting of media, solutions, samples etc. at temperatures below 100°C. It can also be used to maintain constant temperature that is required in microbiology lab work. Several models and types of water bath are available. Fig. 6 shows a typical water bath commonly used in laboratories. It is electrically heated and thermostatically controlled.

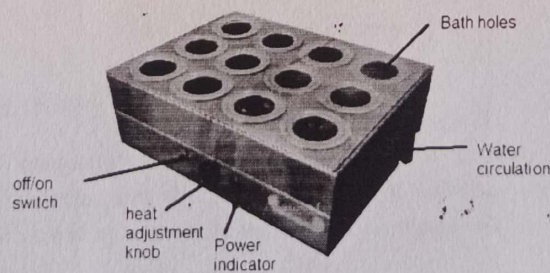

Fig. 6 Boiling water bath

7. Heating mantle

It is an electrically heated and thermostatically controlled unit used to heat or melt samples and reagents. The inner lining is made of asbestos and therefore gives an indirect heat to the materials to be heated. Fig. 7 shows a typical heating mantle being used for heating water in a beaker.

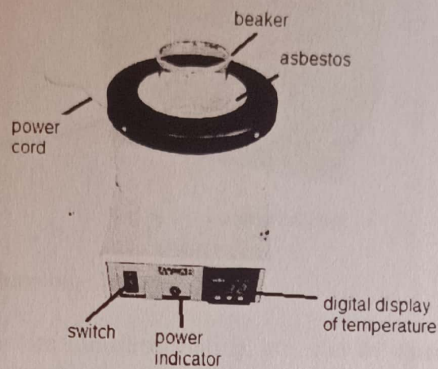

Fig. 7 Heating mantle

8. Hot plate with magnetic stirrer

This is an electrically powered equipment performs the dual function of heating and agitation. The agitation occurs by magnetic arrangement. Any type of glassware can be used for the heating and agitation. Magnetic beads are used for the agitation.

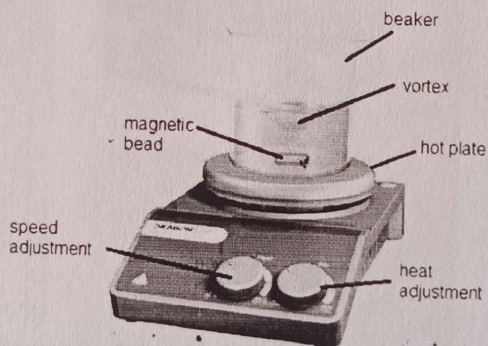

Fig. 8 Hot plate with magnetic stirrer

9. UV chamber / UV viewing cabinet

This equipment is used for analyzing fluorescent materials, spots in thin layer chromatography, etc. The equipment has two lamps for long- and short wavelength UV radiation. Since UV radiation is genotoxic (mutagenic) its exposure to skins and eyes must be avoided. A viewport with colored glass is provided for safety. Fig. 9 shows a typical UV cabinet.

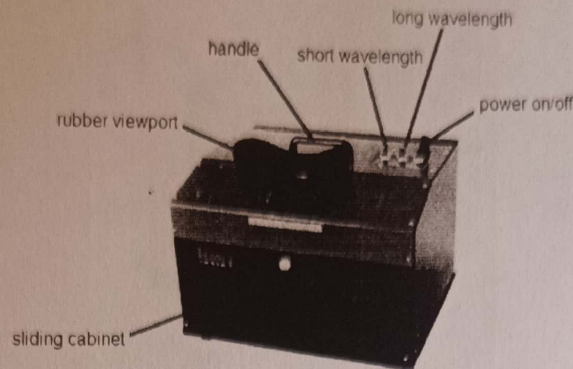

Fig. 9 UV viewing cabinet

11. Inoculation chamber / Sterile chamber

This is an enclosed box in which culture transfers, plating, etc. can be carried out aseptically. The chamber is equipped with UV lamp for periodic disinfection of the chamber. While working, the UV light must be turned off and day-light bulb is turned on. Fig. 10 shows a locally fabricated inoculation chamber.

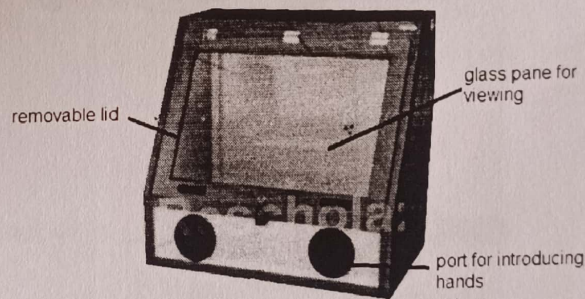

Fig. 10 Inoculation chamber

11 pH meter

pH meter is an electrical instrument used for measuring hydrogen ion concentration of solutions and mixtures (Fig. 11). In microbiology lab, it is used for maintaining pH of the medium and diluents. The pH meter must be standardized with buffer solutions before operation. Since the instrument is very sensitive, it must not be used for stirring and it must not be dipped in hot or very cold solutions. The electrodes must always be kept immersed in suitable solutions. Read the manual carefully before using the instrument.

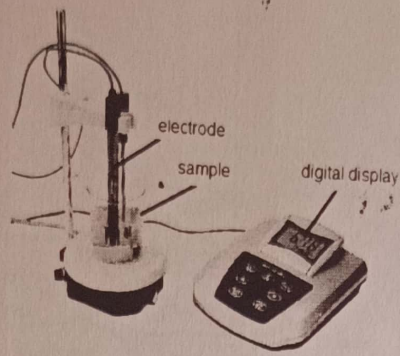

Fig 11 pH meter

12. Colony counter

It is used for counting microbial colony (bacterial and yeast). The instrument is equipped with a backlight source, gridlines and a magnifying lens. It also has a sensor for digitally registering the number of colonies counted (Fig. 12).

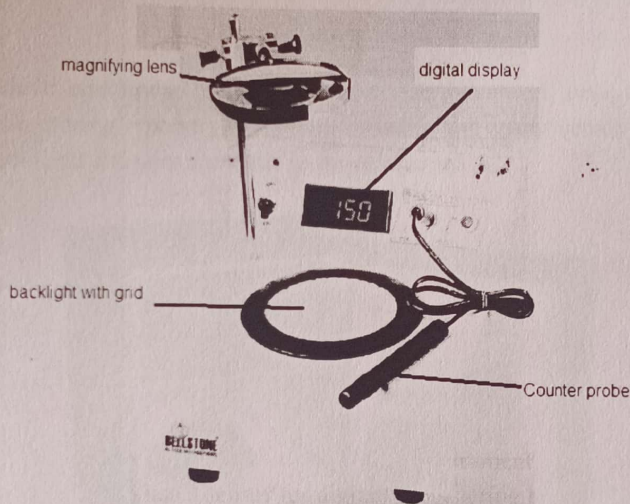

Fig. 12 Colony counter

13. Microscope

It is an instrument for observing microscopic items such as cells, crystals and cell organelles. It has the dual function of magnification and resolution. For routine microbiological works, bright field compound microscope with oil immersion objective is adequate. A compound microscope is shown in Fig. 13.

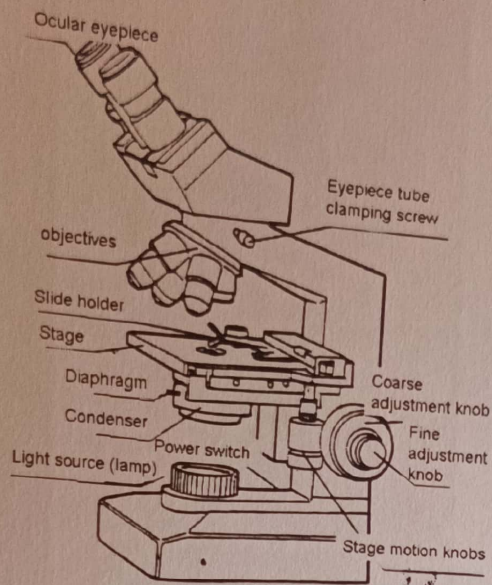

Fig. 13 Compound microscope

14. Refrigerator

This is a common household equipment for keeping foods and beverages cool. This equipment is used in microbiology laboratory for storing / preserving cultures, media, and many sensitive materials (Fig. 14). The equipment is electrically powered and uses ammonia as the refrigerant.

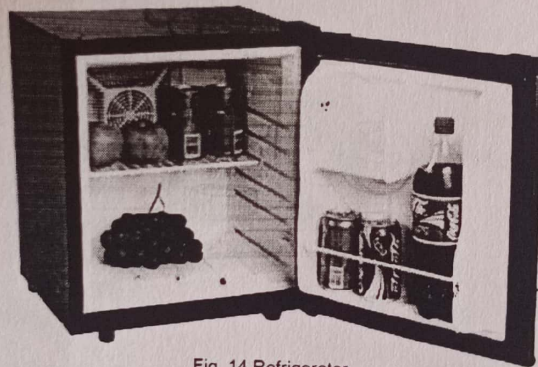

Fig. 14 Refrigerator

15. Bunsen burner

Bunsen burner is a common tool used in science lab (Fig. 15). In microbiology lab, it is used for sterilizing inoculating loop, plating out cultures, transferring cultures, heat-fixing of smears and creating a sterile zone for aseptic operation.

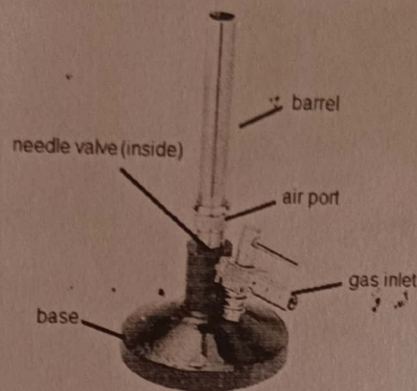

Fig. 15 Bunsen burner

16. Spirit lamp

The function of spirit lamp is the same as the Bunsen burner but is portable. It uses rectified spirit as the fuel (produces smoke-free flame). The lamp must be covered with a lid when not in use to prevent loss of spirit (Fig. 16).

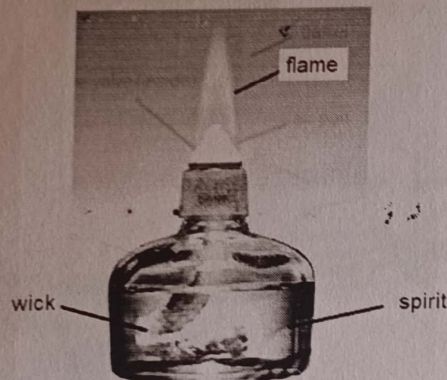

Fig. 16 Spirit lamp

17. Micrometers (stage and ocular)

These are graduated glass pieces (Fig. 17) used for the measurement of size of the cells. Stage micrometer is a slide on which etching is done with 0.001 mm spacing. The ocular micrometer, which is placed on the eyepiece, has an arbitrary scale and must be calibrated against the stage micrometer. During measurements, the ocular micrometer is retained while the stage micrometer is replaced with the specimen slide.

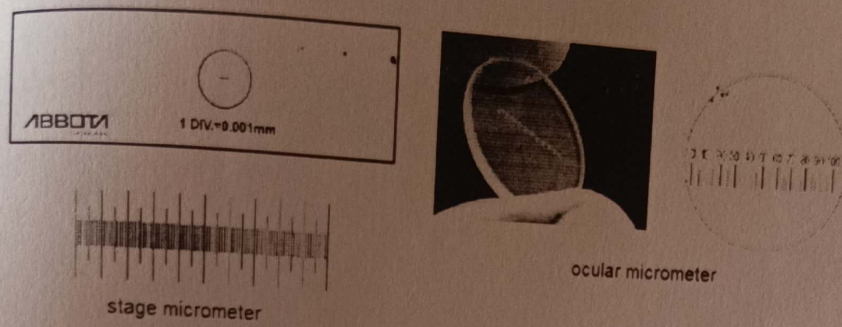

Fig. 17 Stage and ocular micrometer

18. Balance

Balance is needed in microbiology lab for weighing chemicals, samples, media, etc. Digital balances are fast to work with but needs frequent calibration (Fig. 18).

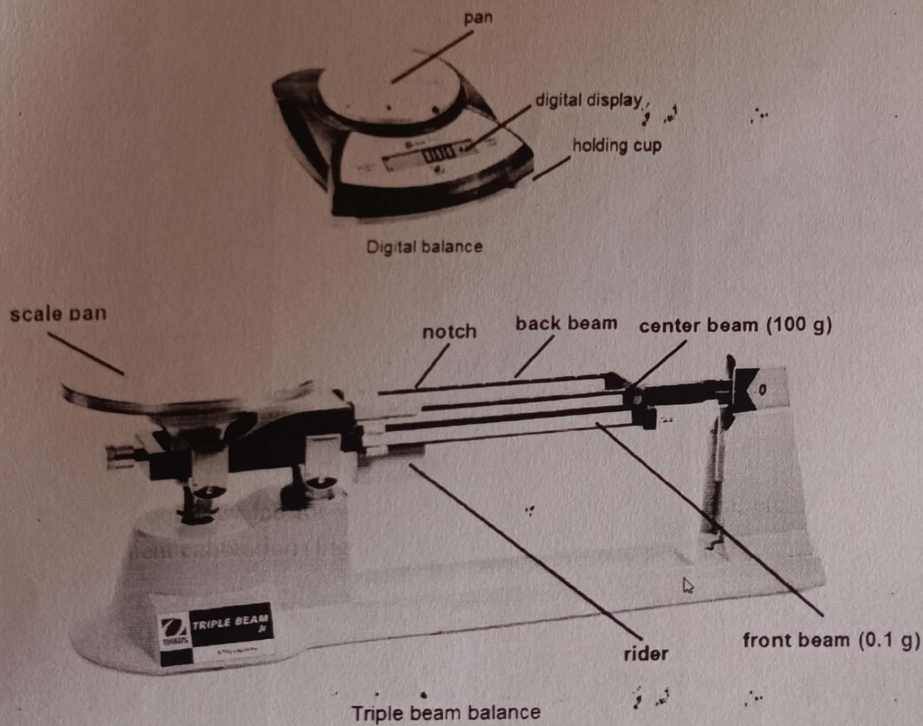

Fig. 18 Different types of balances

The triple-beam and 4-beam balances are robust equipment that need little care and maintenance. Beam balances run on mechanical principles while the principles on which electronic balances run is quite complicated (Fig. 19).

19. Thermometer

Thermometers are required to ensure the heating equipment is running at the correct temperature. The temperature of the medium, incubator, etc., need to be frequently checked. Mercury in glass thermometers are standard

thermometers, the temperature measurement is based on the expansion of mercury present in the bulb. Digital thermometers use probes for measurement of temperatures.

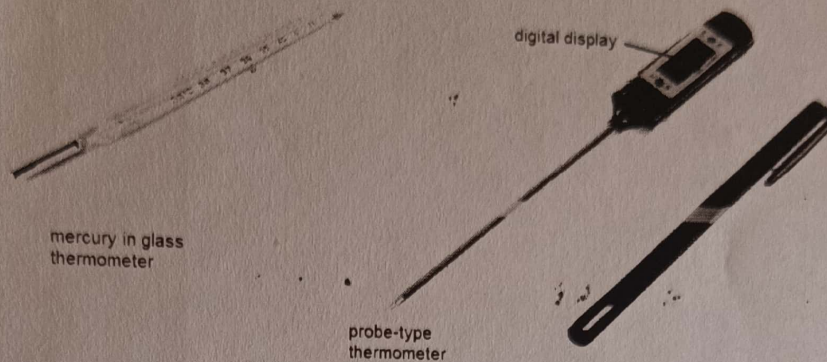

Fig. 19 Different types of thermometers

20. Coliform membrane filter

This glass equipment is used for the testing of coliforms in water (Fig. 20). 100 ml of test water is poured in the funnel and filtered through a special Millipore filter through external application of suction. The filter retains the microorganisms. The filter is then aseptically transferred to a selective-cum-differential semisolid medium kept in a petri dish. If there are coliforms, they will appear as pink dots after incubation at 35°C for 22 hrs.

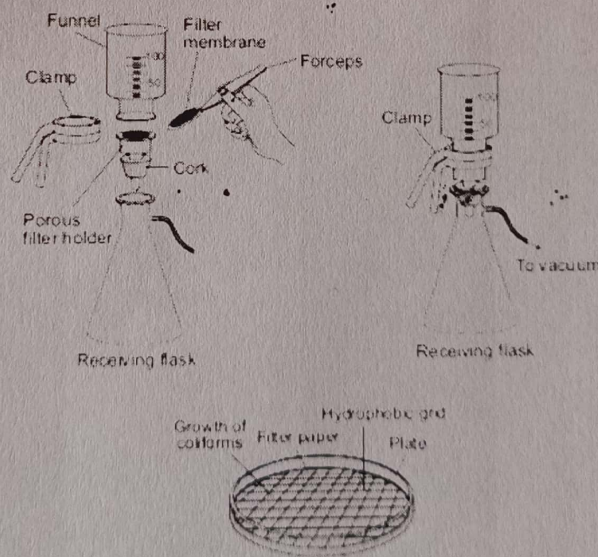

Fig. 20 Coliform membrane filter



V.M.K.S.R.VASTRADARTS, SCIENCE,&
V.S.BELLIHAL COMMERCE COLLEGE HUNGUND.

PROJECTREPORT

College Roll No: 04 Examination seat No: 015142250004

CERTIFICATE

This is to certify that Mr./Miss: Shivashankarappa. R.S. of
B.Sc 1stsemester has satisfactorily completed the visit on
Microbiology equipments of Botany subject as prescribed by the Rani
Chennamma University Belagavi.

During year 2022-2023

Examiner: HOD

1). Dolpud
.....
23/2/23

2). Huleep
.....
23/2/23

[Signature]
Botany
Head of the Department
V.M.K.S.R.Vastrad Arts, Commerce And
Science College Hungund Dist. Daddakot

V.M.S.R VASTRAD ARTS, SCIENCE &
V.S BELLIHAL COMMERCE COLLEGE,
HUNGUND.

MICROBIOLOGY EQUIPMENTS

Project done by

SHIVASHANAKRAPPA.R.SHILAVANTAR

Reg No : U15IY22S0004

BSc 1st Sem

BOTANY

RANI CHENNAMMA UNIVERSITY BELAGAVI

2022-23



List of equipment / apparatus used in microbiology laboratory

1. Autoclave
2. Incubator
3. Hot air oven
4. Inoculating loop
5. Vortex mixer / shaker
6. Water bath
7. Heating mantle
8. Hot plate with magnetic stirrer
9. UV chamber
10. Inoculation chamber
11. pH meter
12. Colony counter
13. Microscope
14. Refrigerator
15. Bunsen burner
16. Spirit lamp
17. Micrometer (stage and ocular)
18. Balance (Digital and 4-beam)
19. Thermometer
20. Membrane filter set

DESCRIPTION

1. Autoclave

It is a robust, electrically heated steam vessel meant for sterilizing 'thermostable' culture media, glassware, and other materials that are not spoiled by moist heat. Autoclave runs on the principle of pressure cooker. The moist heat (steam) has a very good penetrating power. Microorganisms / cells are killed as a result of denaturation of cellular constituents (protein and nucleic acids). In routine process, sterilization can be achieved by operating the autoclave at 121°C (15 psig) for 15 min.

In its simplest form, the equipment has a removable lid for the delivery of materials to be sterilized. It is necessarily equipped with a gasket, pressure-cum-temperature gauge, a vent for letting out air or excess pressure, a safety valve, and a drain. The figure of a portable autoclave is given in Fig. 1.

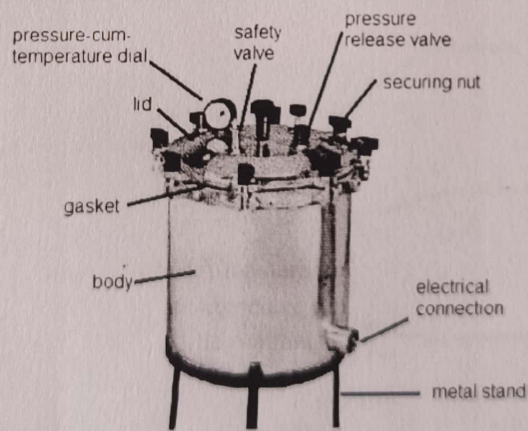

Fig 1 Portable autoclave

2. Incubator

This is an insulated, electrically heated cabinet meant for providing microorganisms with optimum temperature for growth. The cabinet is insulated and thermostatically controlled. For routine purposes, the temperature is maintained at 28-30°C for bacteria, about 25°C for molds, and 35-37°C for mesophilic bacteria. A temperature as

high as 100°C can also be maintained for extremely thermophilic organisms (stereothermophiles). A very common laboratory incubator is shown in Fig. 2.

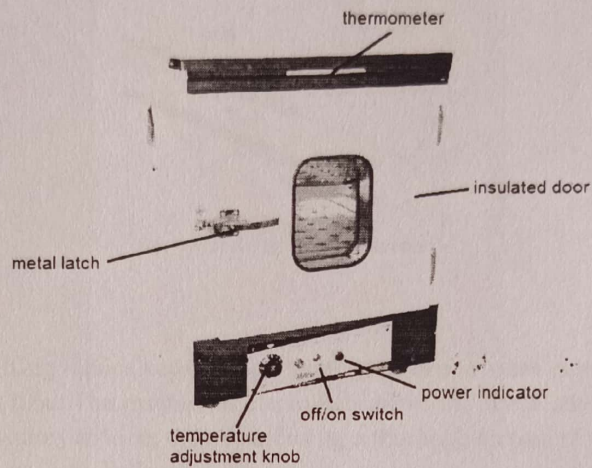

Fig. 2 Incubator

3. Hot air oven

This is similar to incubator in make except that it can operate at temperatures up to 300°C and has a fan for circulating hot air. Hot air oven is used for sterilization of glassware and materials that are spoiled by moist heat. The death of cells occurs due to the oxidation of cellular constituents by the dry heat.

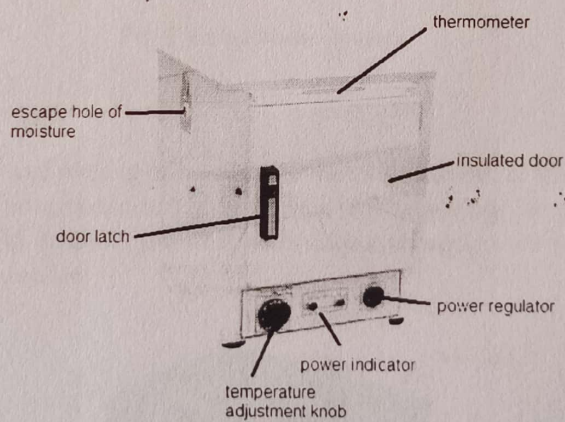

Fig. 3 Hot air oven

For routine purpose, sterilization can be achieved by running the equipment at 180°C for 1.5 hours. Hot air oven is less effective than autoclave. Fig. 3 shows a typical hot air oven popular in microbiology laboratories.

4. Inoculating loop

This is a tool for transferring and streaking cultures. It consists of a thin nichrome wire whose one end is twisted into a small loop while the other end is fixed to a thermoset plastic handle. Sometimes, the looped end is

straightened out to form what is called inoculating needle. Inoculating needles are used for preparing 'stab' cultures. Fig. 4 shows inoculating loops and needles.

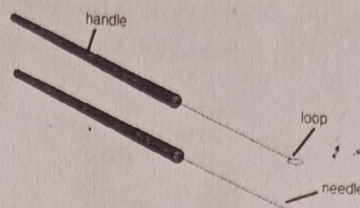

Fig. 4 Inoculating loop and needle

5. Vortex mixer

This equipment is used for mixing liquids kept in a test tube. It has one or more cup-like depressions at the top to receive the bottom of the test tube. The machine is electrically powered. When actuated, the machine moves the bottom of the test tube in a gyratory motion, thereby affecting a thorough mixing of the solution. The speed of the mixer can be varied. Fig. 5 shows a typical vortex mixer.

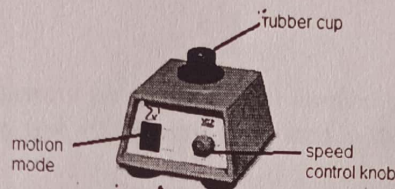

Fig. 5 Vortex mixer / shaker

6. Water bath / Boiling water bath

Water bath is used for heating and melting of media, solutions, samples etc. at temperatures below 100°C. It can also be used to maintain constant temperature that is required in microbiology lab work. Several models and types of water bath are available. Fig. 6 shows a typical water bath commonly used in laboratories. It is electrically heated and thermostatically controlled.

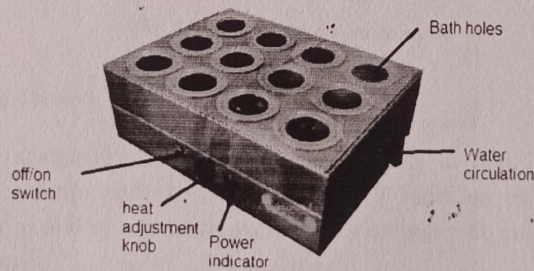

Fig. 6 Boiling water bath

7. Heating mantle

It is an electrically heated and thermostatically controlled unit used to heat or melt samples and reagents. The inner lining is made of asbestos and therefore gives an indirect heat to the materials to be heated. Fig. 7 shows a typical heating mantle being used for heating water in a beaker.

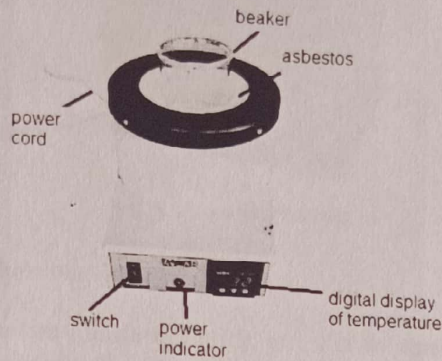

Fig. 7 Heating mantle

8. Hot plate with magnetic stirrer

This is an electrically powered equipment performs the dual function of heating and agitation. The agitation occurs by magnetic arrangement. Any type of glassware can be used for the heating and agitation. Magnetic beads are used for the agitation.

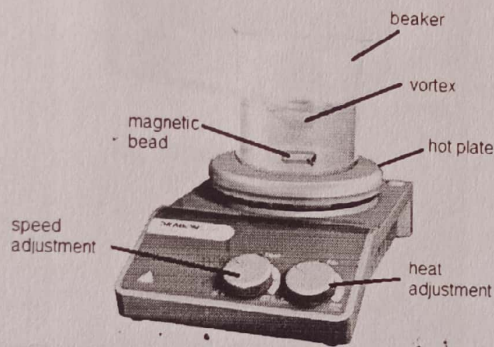

Fig. 8 Hot plate with magnetic stirrer

9. UV chamber / UV viewing cabinet

This equipment is used for analyzing fluorescent materials, spots in thin layer chromatography, etc. The equipment has two lamps for long- and short wavelength UV radiation. Since UV radiation is genotoxic (mutagenic) its exposure to skins and eyes must be avoided. A viewport with colored glass is provided for safety. Fig. 9 shows a typical UV cabinet.

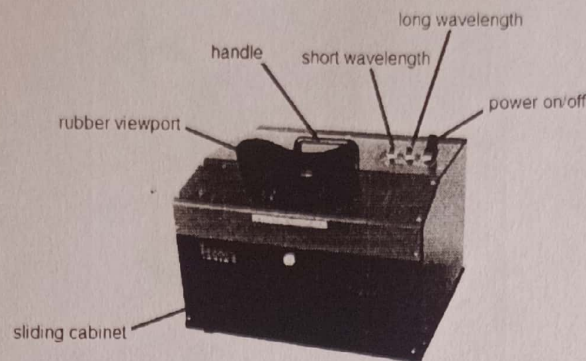

Fig. 9 UV viewing cabinet

11. Inoculation chamber / Sterile chamber

This is an enclosed box in which culture transfers, plating, etc. can be carried out aseptically. The chamber is equipped with UV lamp for periodic disinfection of the chamber. While working, the UV light must be turned off and day-light bulb is turned on. Fig. 10 shows a locally fabricated inoculation chamber.

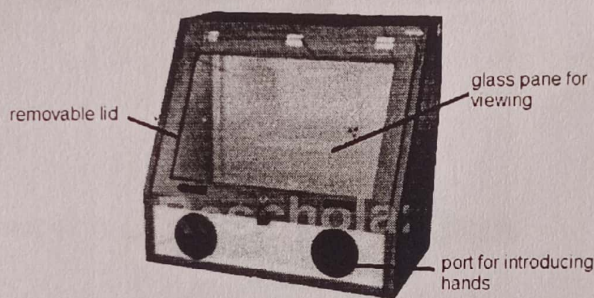

Fig. 10 Inoculation chamber

11 pH meter

pH meter is an electrical instrument used for measuring hydrogen ion concentration of solutions and mixtures (Fig. 11). In microbiology lab, it is used for maintaining pH of the medium and diluents. The pH meter must be standardized with buffer solutions before operation. Since the instrument is very sensitive, it must not be used for stirring and it must not be dipped in hot or very cold solutions. The electrodes must always be kept immersed in suitable solutions. Read the manual carefully before using the instrument.

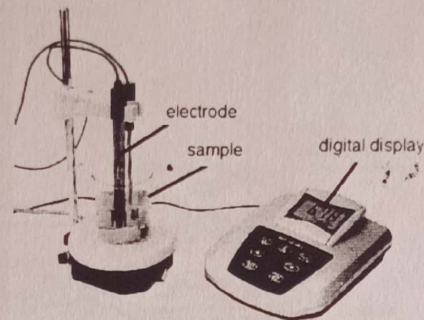

Fig. 11 pH meter

12. Colony counter

It is used for counting microbial colony (bacterial and yeast). The instrument is equipped with a backlight source, gridlines and a magnifying lens. It also has a sensor for digitally registering the number of colonies counted (Fig. 12).

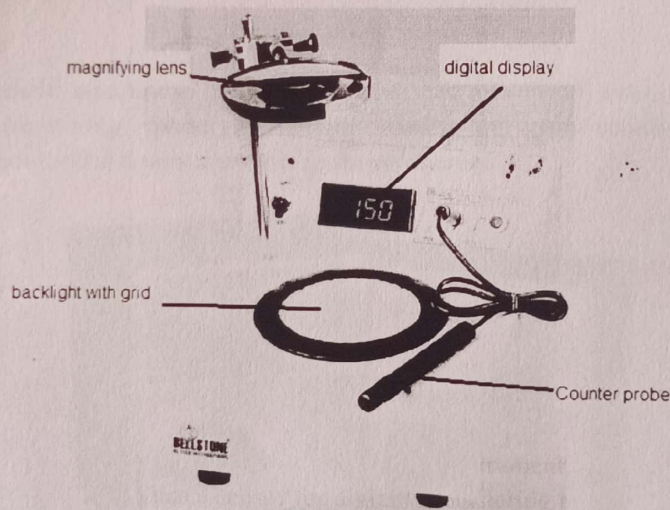

Fig. 12 Colony counter

13. Microscope

It is an instrument for observing microscopic items such as cells, crystals and cell organelles. It has the dual function of magnification and resolution. For routine microbiological works, bright field compound microscope with oil immersion objective is adequate. A compound microscope is shown in Fig. 13.

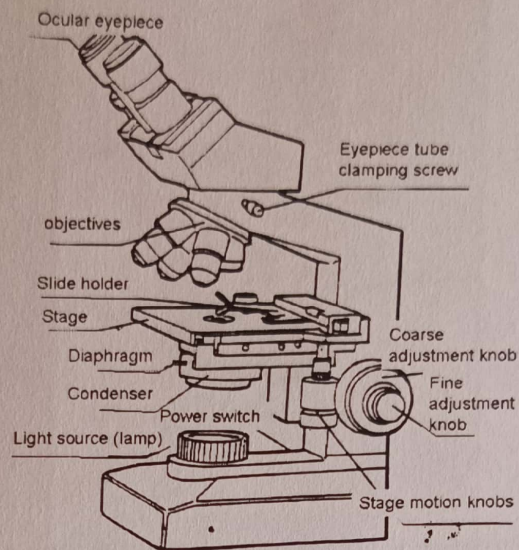

Fig. 13 Compound microscope

14. Refrigerator

This is a common household equipment for keeping foods and beverages cool. This equipment is used in microbiology laboratory for storing / preserving cultures, media, and many sensitive materials (Fig. 14). The equipment is electrically powered and uses ammonia as the refrigerant.

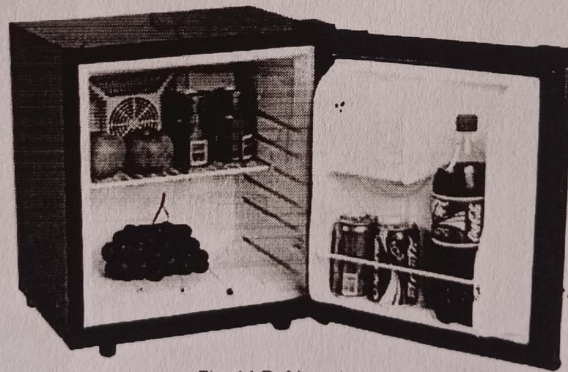

Fig. 14 Refrigerator

15. Bunsen burner

Bunsen burner is a common tool used in science lab (Fig. 15). In microbiology lab, it is used for sterilizing inoculating loop, plating out cultures, transferring cultures, heat-fixing of smears and creating a sterile zone for aseptic operation.

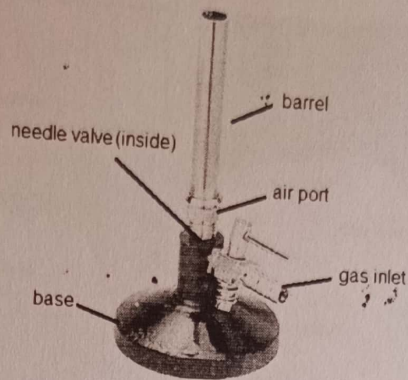

Fig 15 Bunsen burner

16. Spirit lamp

The function of spirit lamp is the same as the Bunsen burner but is portable. It uses rectified spirit as the fuel (produces smoke-free flame). The lamp must be covered with a lid when not in use to prevent loss of spirit (Fig. 16).

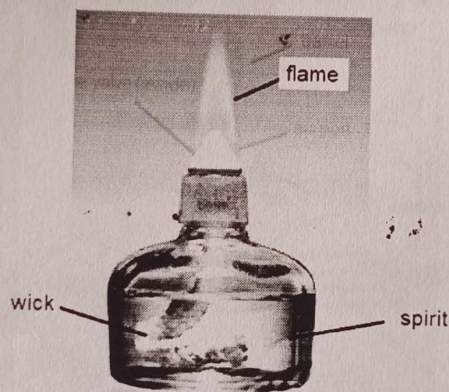

Fig. 16 Spirit lamp

17. Micrometers (stage and ocular)

These are graduated glass pieces (Fig. 17) used for the measurement of size of the cells. Stage micrometer is a slide on which etching is done with 0.001 mm spacing. The ocular micrometer, which is placed on the eyepiece, has an arbitrary scale and must be calibrated against the stage micrometer. During measurements, the ocular micrometer is retained while the stage micrometer is replaced with the specimen slide.

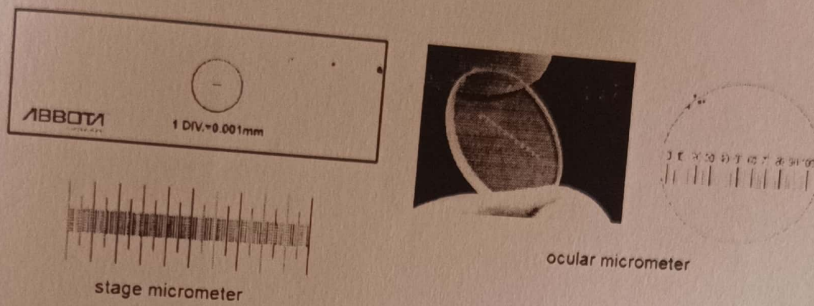

Fig. 17 Stage and ocular micrometer

18. Balance

Balance is needed in microbiology lab for weighing chemicals, samples, media, etc. Digital balances are fast to work with but needs frequent calibration (Fig. 18).

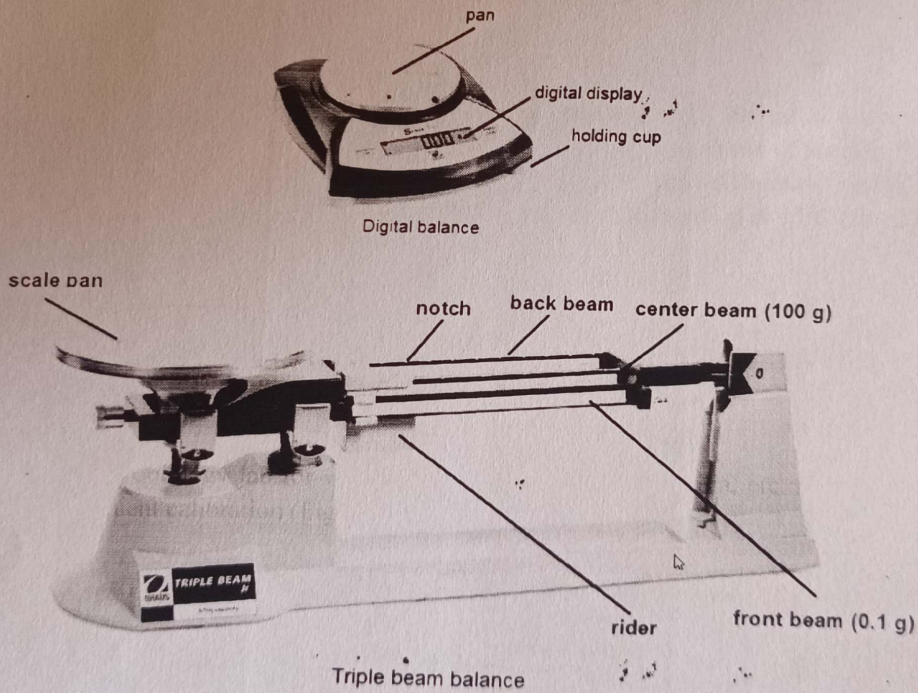

Fig. 18 Different types of balances

The triple-beam and 4-beam balances are robust equipment that need little care and maintenance. Beam balances run on mechanical principles while the principles on which electronic balances run is quite complicated (Fig. 19).

19. Thermometer

Thermometers are required to ensure the heating equipment is running at the correct temperature. The temperature of the medium, incubator, etc., need to be frequently checked. Mercury in glass thermometers are standard

thermometers, the temperature measurement is based on the expansion of mercury present in the bulb. Digital thermometers use probes for measurement of temperatures.

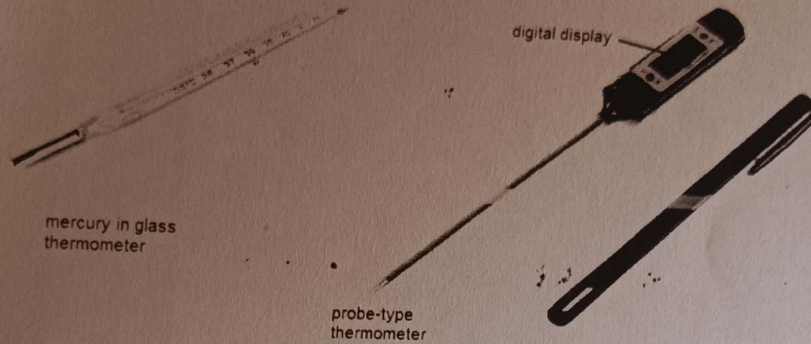

Fig. 19 Different types of thermometers

20. Coliform membrane filter

This glass equipment is used for the testing of coliforms in water (Fig. 20). 100 ml of test water is poured in the funnel and filtered through a special Millipore filter through external application of suction. The filter retains the microorganisms. The filter is then aseptically transferred to a selective-cum-differential semisolid medium kept in a petri dish. If there are coliforms, they will appear as pink dots after incubation at 35°C for 22 hrs.

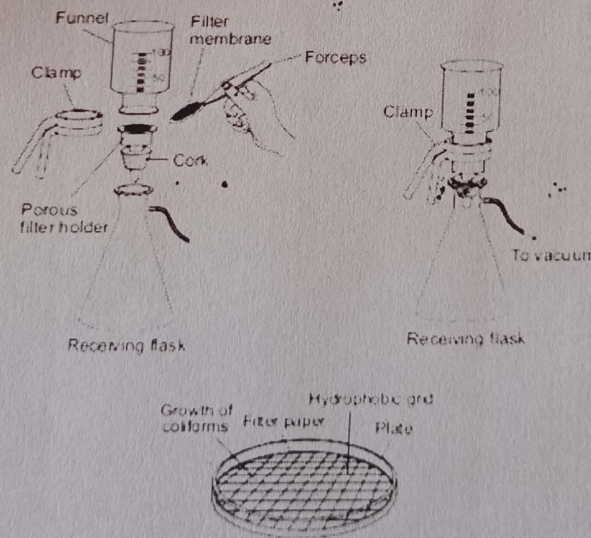
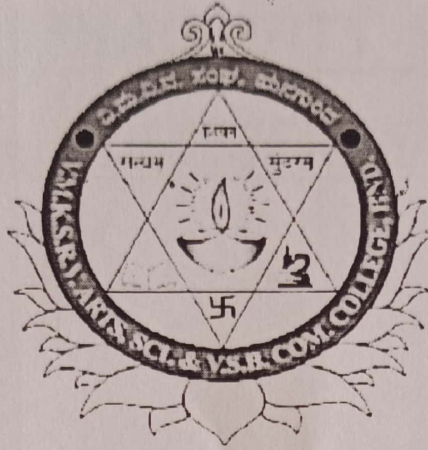

Fig. 20 Coliform membrane filter



V.M.K.S.R. VASTRADARTS, SCIENCE, &
V.S. BELLIHAL COMMERCE COLLEGE HUNGUND.

PROJECT REPORT

College Roll No: 88 Examination seat No: U15I422S0025

CERTIFICATE

This is to certify that Mr./Miss: Aishwarya C. Upanal of
B.Sc 1st semester has satisfactorily completed the visit on
Microbiology equipments of Botany subject as prescribed by the Rani
Chennamma University Belagavi.

During year 2022-2023

Examiner: HOD

1). D. K. P. S.
23/12/23

2). H. S. S.
23/13/23

S. S. S.
Botany
Head of the Department
V.M.K.S.R. Vastrad Arts, Commerce & Science
College, Hungund, Dist. Bellary

**V.M.S.R VASTRAD ARTS, SCIENCE &
V.S BELLIHAL COMMERCE COLLEGE,
HUNGUND.**

MICROBIOLOGY EQUIPMENTS

Project done by

AISHWARYA.C.UPANAL

Reg No : U15IY22S0025

BSc 1st Sem

BOTANY

RANI CHENNAMMA UNIVERSITY BELAGAVI

2022-23



List of equipment / apparatus used in microbiology laboratory

1. Autoclave
2. Incubator
3. Hot air oven
4. Inoculating loop
5. Vortex mixer / shaker
6. Water bath
7. Heating mantle
8. Hot plate with magnetic stirrer
9. UV chamber
10. Inoculation chamber
11. pH meter
12. Colony counter
13. Microscope
14. Refrigerator
15. Bunsen burner
16. Spirit lamp
17. Micrometer (stage and ocular)
18. Balance (Digital and 4-beam)
19. Thermometer
20. Membrane filter set

DESCRIPTION

1. Autoclave

It is a robust, electrically heated steam vessel meant for sterilizing 'thermostable' culture media, glassware, and other materials that are not spoiled by moist heat. Autoclave runs on the principle of pressure cooker. The moist heat (steam) has a very good penetrating power. Microorganisms / cells are killed as a result of denaturation of cellular constituents (protein and nucleic acids). In routine process, sterilization can be achieved by operating the autoclave at 121°C (15 psig) for 15 min.

In its simplest form, the equipment has a removable lid for the delivery of materials to be sterilized. It is necessarily equipped with a gasket, pressure-cum-temperature gauge, a vent for letting out air or excess pressure, a safety valve, and a drain. The figure of a portable autoclave is given in Fig. 1.

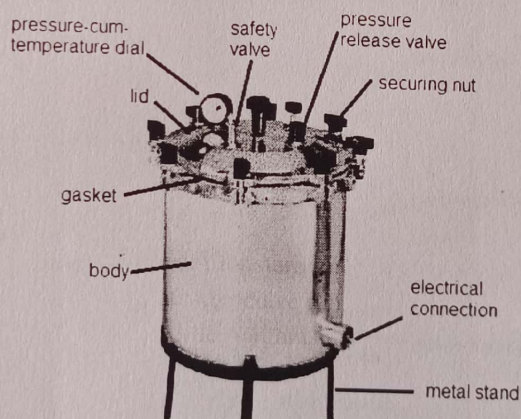

Fig 1 Portable autoclave

2. Incubator

This is an insulated, electrically heated cabinet meant for providing microorganisms with optimum temperature for growth. The cabinet is insulated and thermostatically controlled. For routine purposes, the temperature is maintained at 28-30°C for bacteria, about 25°C for molds, and 35-37°C for mesophilic bacteria. A temperature as

high as 100°C can also be maintained for extremely thermophilic organisms (stereothermophiles). A very common laboratory incubator is shown in Fig. 2.

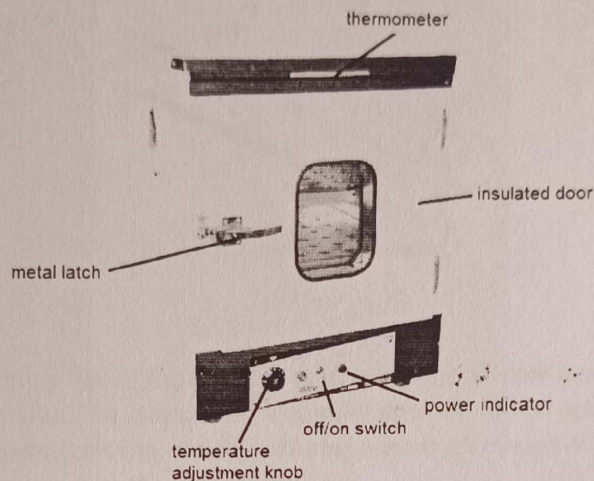

Fig. 2 Incubator

3. Hot air oven

This is similar to incubator in make except that it can operate at temperatures up to 300°C and has a fan for circulating hot air. Hot air oven is used for sterilization of glassware and materials that are spoiled by moist heat. The death of cells occurs due to the oxidation of cellular constituents by the dry heat.

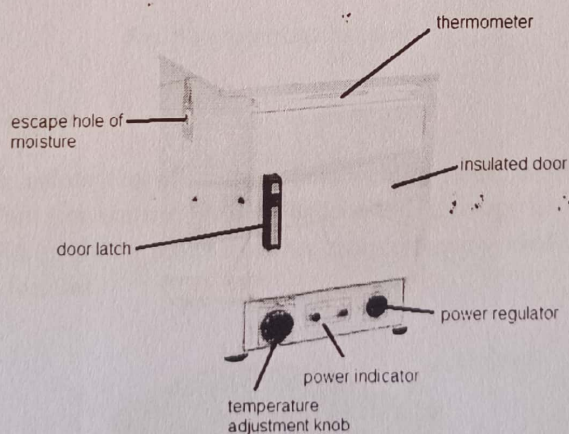

Fig. 3 Hot air oven

For routine purpose, sterilization can be achieved by running the equipment at 180°C for 1.5 hours. Hot air oven is less effective than autoclave. Fig. 3 shows a typical hot air oven popular in microbiology laboratories.

4. Inoculating loop

This is a tool for transferring and streaking cultures. It consists of a thin nichrome wire whose one end is twisted into a small loop while the other end is fixed to a thermoset plastic handle. Sometimes, the looped end is

straightened out to form what is called inoculating needle. Inoculating needles are used for preparing 'stab' cultures. Fig. 4 shows inoculating loops and needles.

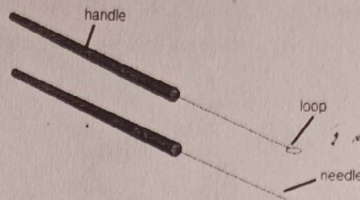

Fig. 4 Inoculating loop and needle

5. Vortex mixer

This equipment is used for mixing liquids kept in a test tube. It has one or more cup-like depressions at the top to receive the bottom of the test tube. The machine is electrically powered. When actuated, the machine moves the bottom of the test tube in a gyratory motion, thereby affecting a thorough mixing of the solution. The speed of the mixer can be varied. Fig. 5 shows a typical vortex mixer.

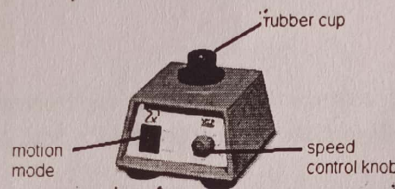

Fig. 5 Vortex mixer / shaker

6. Water bath / Boiling water bath

Water bath is used for heating and melting of media, solutions, samples etc. at temperatures below 100°C. It can also be used to maintain constant temperature that is required in microbiology lab work. Several models and types of water bath are available. Fig. 6 shows a typical water bath commonly used in laboratories. It is electrically heated and thermostatically controlled.

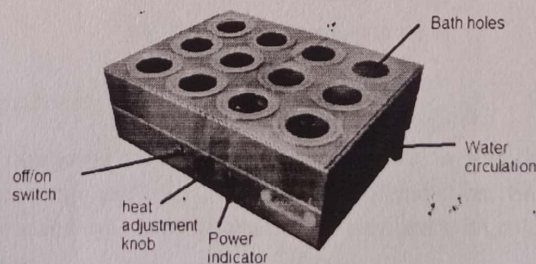

Fig. 6 Boiling water bath

7. Heating mantle

It is an electrically heated and thermostatically controlled unit used to heat or melt samples and reagents. The inner lining is made of asbestos and therefore gives an indirect heat to the materials to be heated. Fig. 7 shows a typical heating mantle being used for heating water in a beaker.

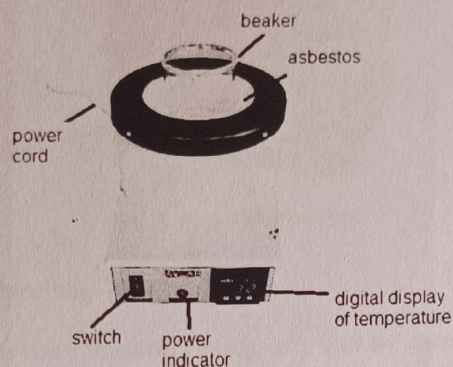

Fig. 7 Heating mantle

8. Hot plate with magnetic stirrer

This is an electrically powered equipment performs the dual function of heating and agitation. The agitation occurs by magnetic arrangement. Any type of glassware can be used for the heating and agitation. Magnetic beads are used for the agitation.

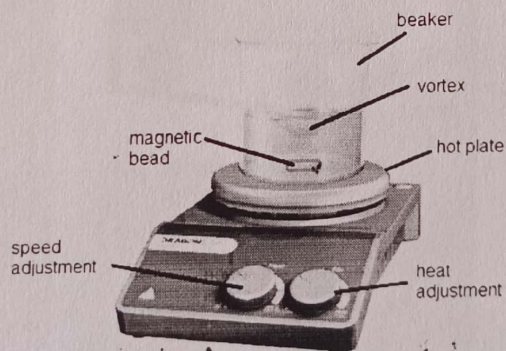

Fig. 8 Hot plate with magnetic stirrer

9. UV chamber / UV viewing cabinet

This equipment is used for analyzing fluorescent materials, spots in thin layer chromatography, etc. The equipment has two lamps for long- and short wavelength UV radiation. Since UV radiation is genotoxic (mutagenic) its exposure to skins and eyes must be avoided. A viewport with colored glass is provided for safety. Fig. 9 shows a typical UV cabinet.

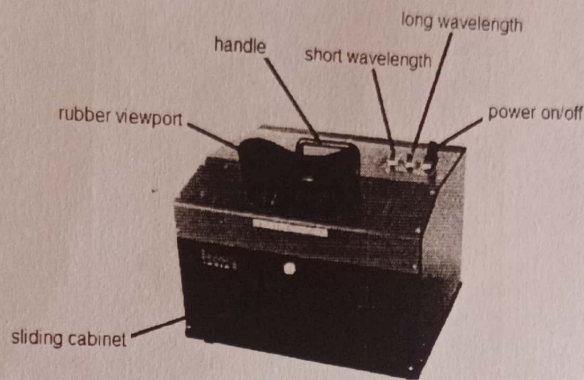

Fig. 9 UV viewing cabinet

11. Inoculation chamber / Sterile chamber

This is an enclosed box in which culture transfers, plating, etc. can be carried out aseptically. The chamber is equipped with UV lamp for periodic disinfection of the chamber. While working, the UV light must be turned off and day-light bulb is turned on. Fig. 10 shows a locally fabricated inoculation chamber.

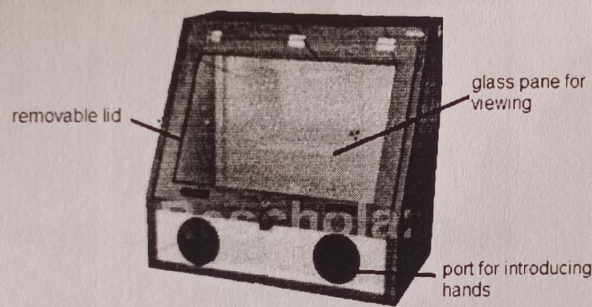

Fig. 10 Inoculation chamber

11 pH meter

pH meter is an electrical instrument used for measuring hydrogen ion concentration of solutions and mixtures (Fig. 11). In microbiology lab, it is used for maintaining pH of the medium and diluents. The pH meter must be standardized with buffer solutions before operation. Since the instrument is very sensitive, it must not be used for stirring and it must not be dipped in hot or very cold solutions. The electrodes must always be kept immersed in suitable solutions. Read the manual carefully before using the instrument.

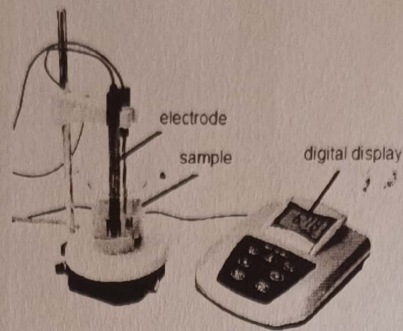

Fig. 11 pH meter

12. Colony counter

It is used for counting microbial colony (bacterial and yeast). The instrument is equipped with a backlight source, gridlines and a magnifying lens. It also has a sensor for digitally registering the number of colonies counted (Fig. 12).

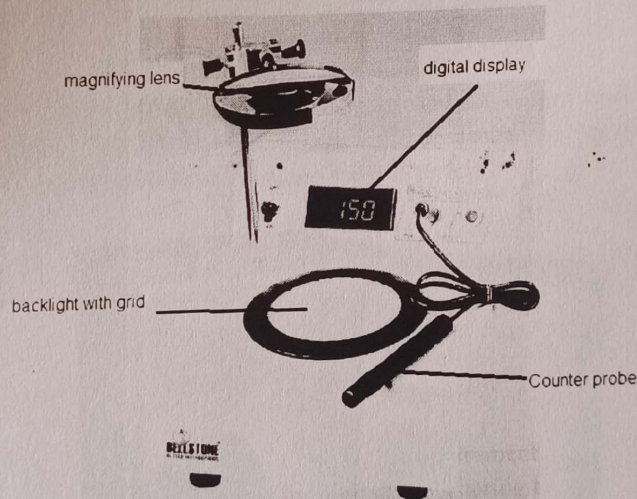

Fig. 12 Colony counter

13. Microscope

It is an instrument for observing microscopic items such as cells, crystals and cell organelles. It has the dual function of magnification and resolution. For routine microbiological works, bright field compound microscope with oil immersion objective is adequate. A compound microscope is shown in Fig. 13.

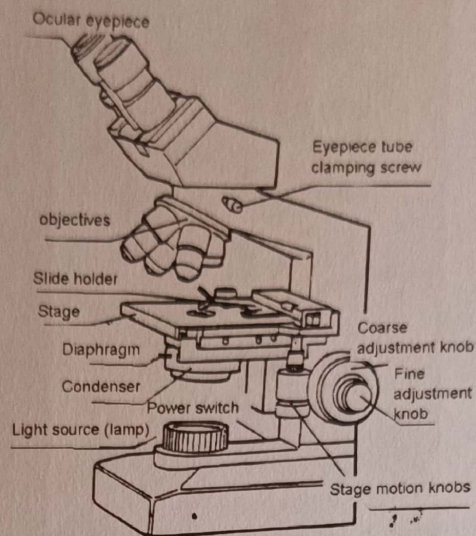

Fig. 13 Compound microscope

14. Refrigerator

This is a common household equipment for keeping foods and beverages cool. This equipment is used in microbiology laboratory for storing / preserving cultures, media, and many sensitive materials (Fig. 14). The equipment is electrically powered and uses ammonia as the refrigerant.

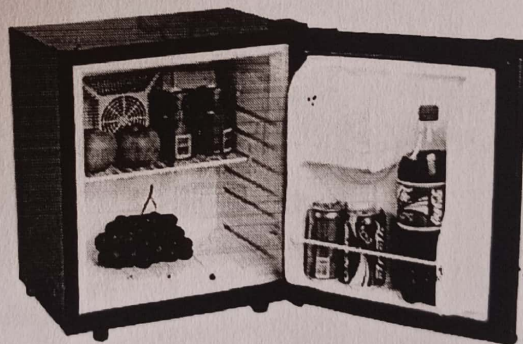

Fig. 14 Refrigerator

15. Bunsen burner

Bunsen burner is a common tool used in science lab (Fig. 15). In microbiology lab, it is used for sterilizing inoculating loop, plating out cultures, transferring cultures, heat-fixing of smears and creating a sterile zone for aseptic operation.

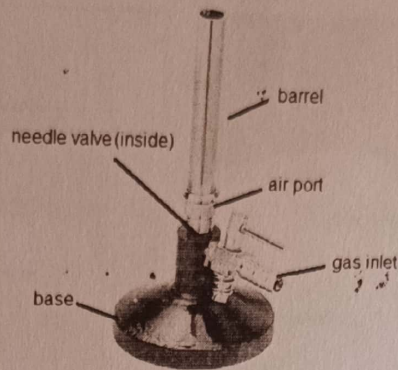

Fig 15 Bunsen burner

16. Spirit lamp

The function of spirit lamp is the same as the Bunsen burner but is portable. It uses rectified spirit as the fuel (produces smoke-free flame). The lamp must be covered with a lid when not in use to prevent loss of spirit (Fig. 16).

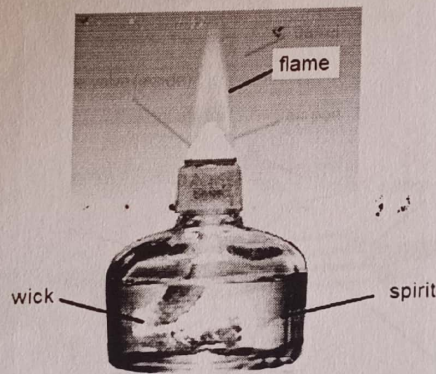

Fig. 16 Spirit lamp

17. Micrometers (stage and ocular)

These are graduated glass pieces (Fig. 17) used for the measurement of size of the cells. Stage micrometer is a slide on which etching is done with 0.001 mm spacing. The ocular micrometer, which is placed on the eyepiece, has an arbitrary scale and must be calibrated against the stage micrometer. During measurements, the ocular micrometer is retained while the stage micrometer is replaced with the specimen slide.

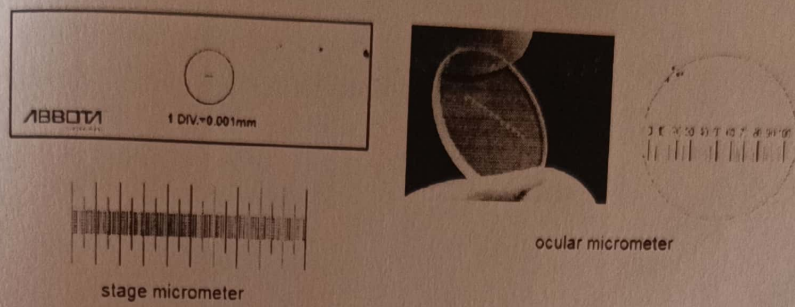

Fig. 17 Stage and ocular micrometer

18. Balance

Balance is needed in microbiology lab for weighing chemicals, samples, media, etc. Digital balances are fast to work with but needs frequent calibration (Fig. 18).

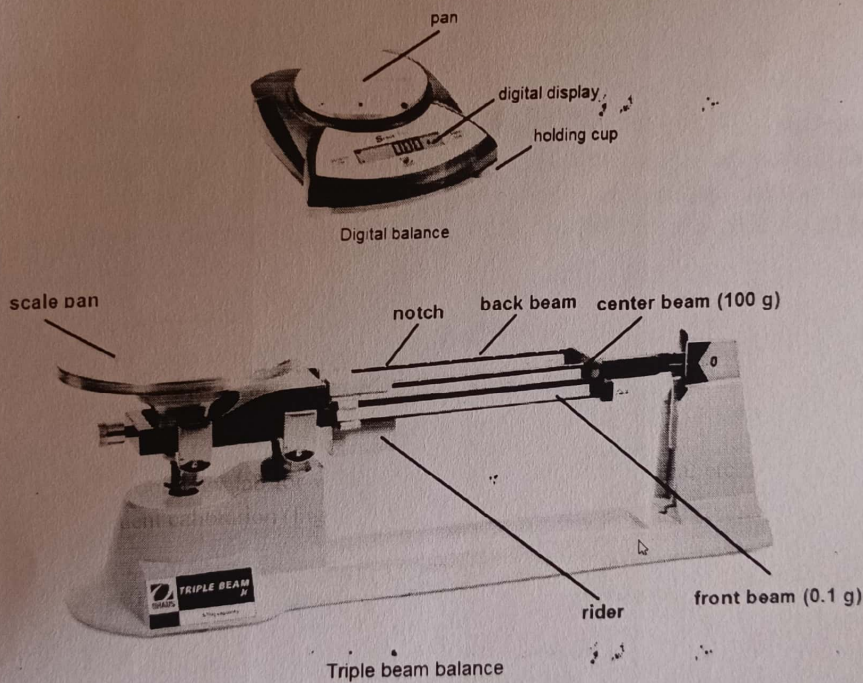

Fig. 18 Different types of balances

The triple-beam and 4-beam balances are robust equipment that need little care and maintenance. Beam balances run on mechanical principles while the principles on which electronic balances run is quite complicated (Fig. 19).

19. Thermometer

Thermometers are required to ensure the heating equipment is running at the correct temperature. The temperature of the medium, incubator, etc., need to be frequently checked. Mercury in glass thermometers are standard

thermometers, the temperature measurement is based on the expansion of mercury present in the bulb. Digital thermometers use probes for measurement of temperatures.

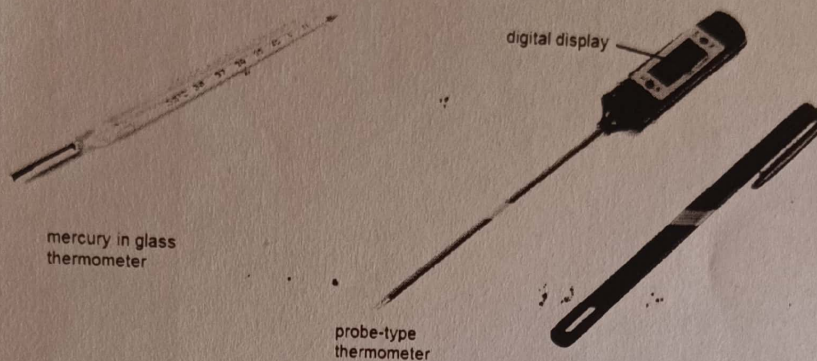

Fig. 19 Different types of thermometers

20. Coliform membrane filter

This glass equipment is used for the testing of coliforms in water (Fig. 20). 100 ml of test water is poured in the funnel and filtered through a special Millipore filter through external application of suction. The filter retains the microorganisms. The filter is then aseptically transferred to a selective-cum-differential semisolid medium kept in a petri dish. If there are coliforms, they will appear as pink dots after incubation at 35°C for 22 hrs.

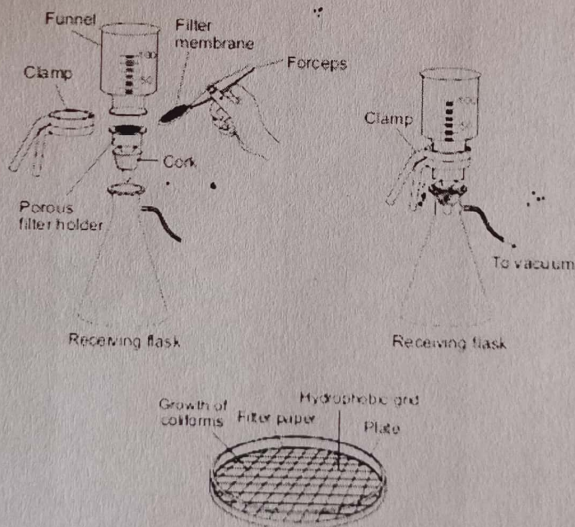

Fig. 20 Coliform membrane filter